



NYOCHINA

中华青少年交响乐团



2019

| 欧 | 洲 | 巡 | 演 |

CLASS OF 2019

2019

欧 | 洲 | 巡 | 演 |



曹宇博 | 中央音乐学院附中



小
提
琴



NYO CHINA
中华青少年交响乐团

2019

| 欧 | 洲 | 巡 | 演 |

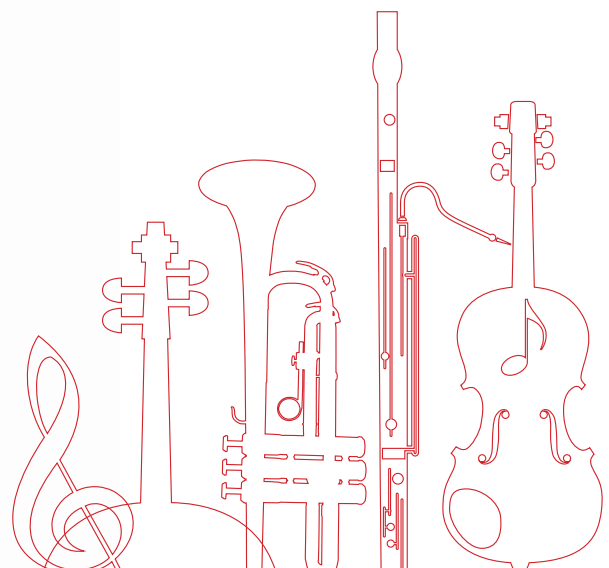

小
提
琴



常倩 | 新加坡杨秀桃音乐学院

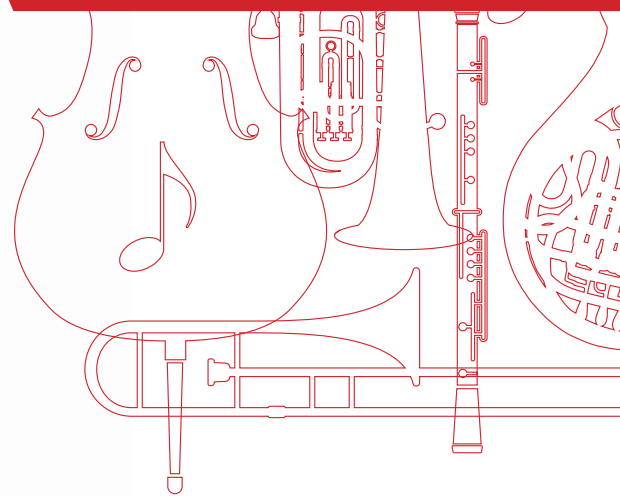

NYO CHINA
中华青少年交响乐团

2019

欧 | 洲 | 巡 | 演 |



小
提
琴

陈钟翰 | 上海音乐学院附中



NYO CHINA
中华青少年交响乐团

2019

欧 | 洲 | 巡 | 演 |

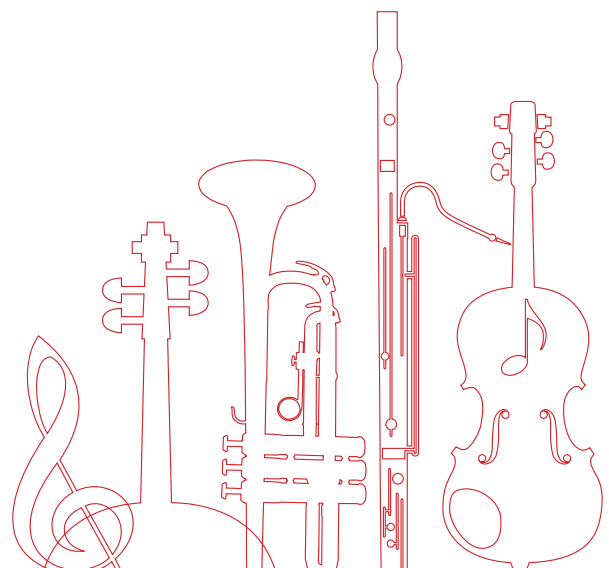

小
提
琴



冯瀚语 | 中国音乐学院附中

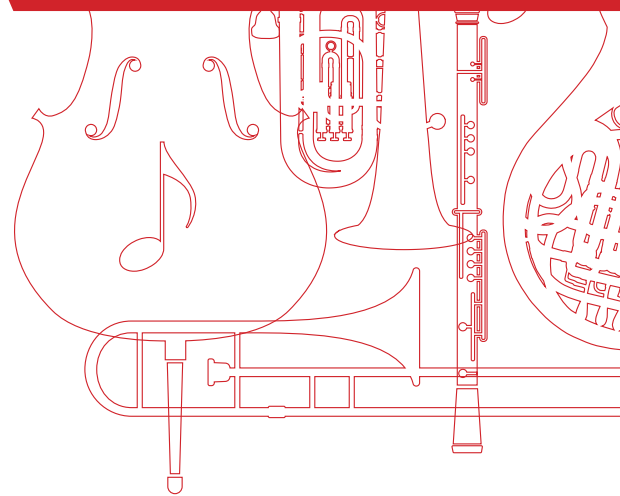

NYO CHINA
中华青少年交响乐团

2019

欧 | 洲 | 巡 | 演 |



傅怡青

美国约翰霍普金斯
皮博迪音乐学院



小
提
琴



NYO CHINA
中华青少年交响乐团

2019

| 欧 | 洲 | 巡 | 演 |

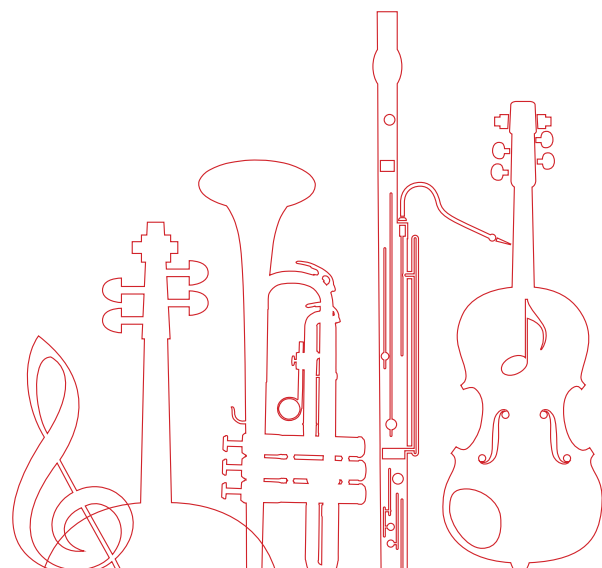

小提琴



康耘茂 | 天津音乐学院附中

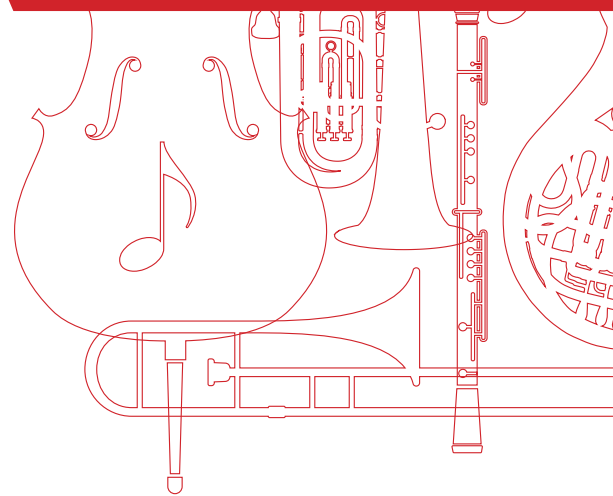

NYO CHINA
中华青少年交响乐团

2019

欧 | 洲 | 巡 | 演 |



小
提
琴

雷童童 | 美国新英格兰音乐学院

NYO CHINA
中华青少年交响乐团

2019

欧 | 洲 | 巡 | 演 |



小
提
琴



李世杰 | 中央音乐学院附中

NYO CHINA
中华青少年交响乐团

2019

欧 | 洲 | 巡 | 演 |



李思颖 | 中央音乐学院附中



小
提
琴

NYO CHINA
中华青少年交响乐团

2019

| 欧 | 洲 | 巡 | 演 |

小
提
琴

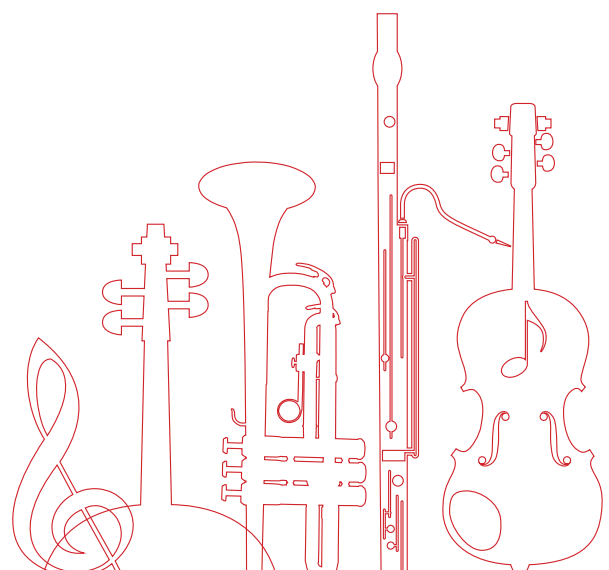

李卓伦 | 天津音乐学院附中

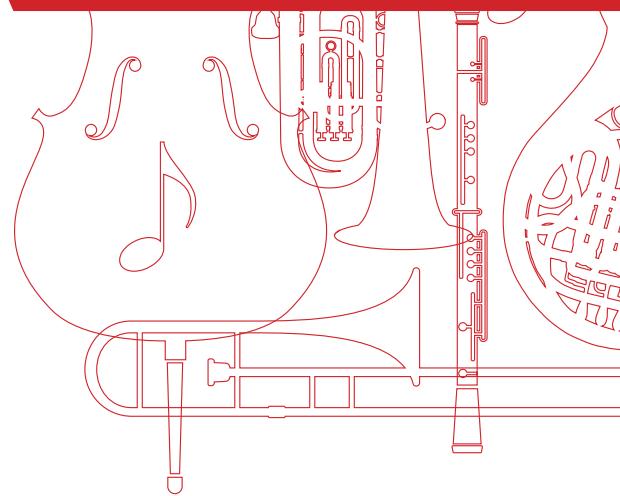

NYO CHINA
中华青少年交响乐团

2019

欧 | 洲 | 巡 | 演 |



小
提
琴

廉贞美 | 中央音乐学院



NYO CHINA
中华青少年交响乐团

2019

| 欧 | 洲 | 巡 | 演 |

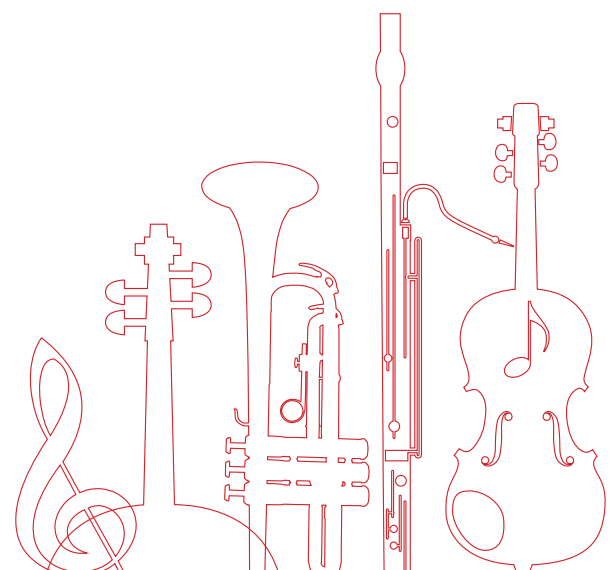

小
提
琴



马天炜 | 中央音乐学院附中

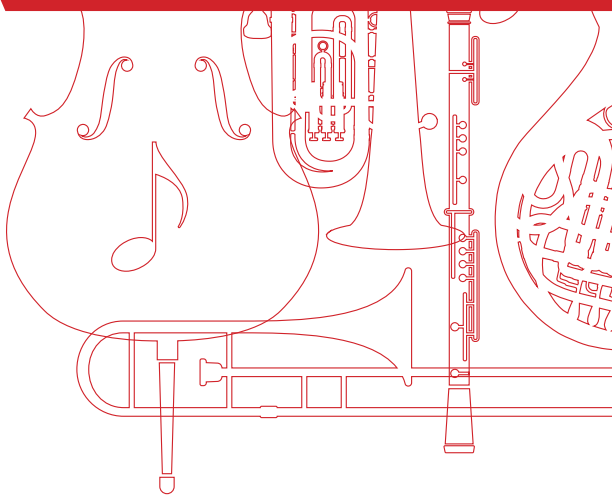

NYO CHINA
中华青少年交响乐团

2019

欧 | 洲 | 巡 | 演 |



小
提
琴

潘俏颖 | 中央音乐学院附中

NYO CHINA
中华青少年交响乐团

2019

| 欧 | 洲 | 巡 | 演 |



小
提
琴



沙子力 | 美国约翰霍普金斯
皮博迪音乐学院

NYO CHINA
中华青少年交响乐团

2019

欧 | 洲 | 巡 | 演 |



小
提
琴

史兆楠 | 中央音乐学院



NYO CHINA
中华青少年交响乐团

2019

| 欧 | 洲 | 巡 | 演 |

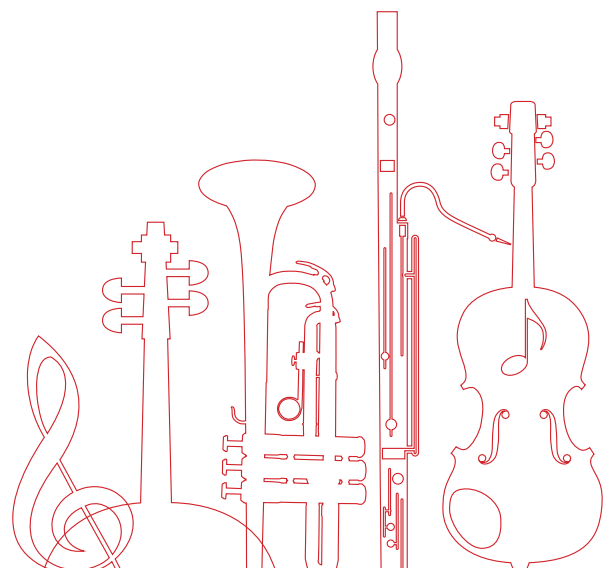

小
提
琴



孙泽毅 | 上海音乐学院

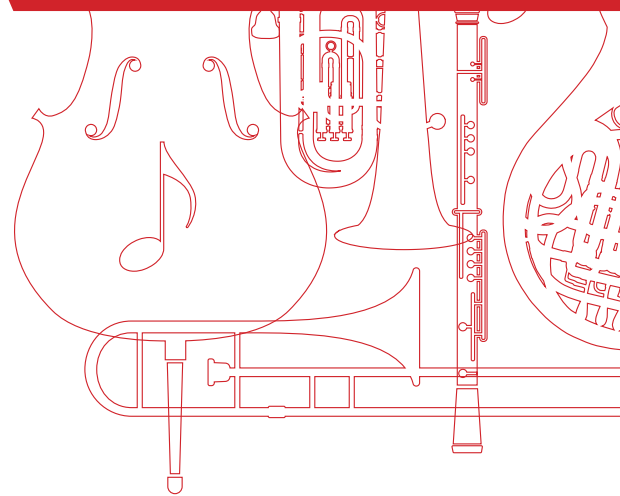

NYO CHINA
中华青少年交响乐团

2019

欧 | 洲 | 巡 | 演 |



小
提
琴

田元 | 天普大学



NYO CHINA
中华青少年交响乐团

2019

欧 | 洲 | 巡 | 演 |

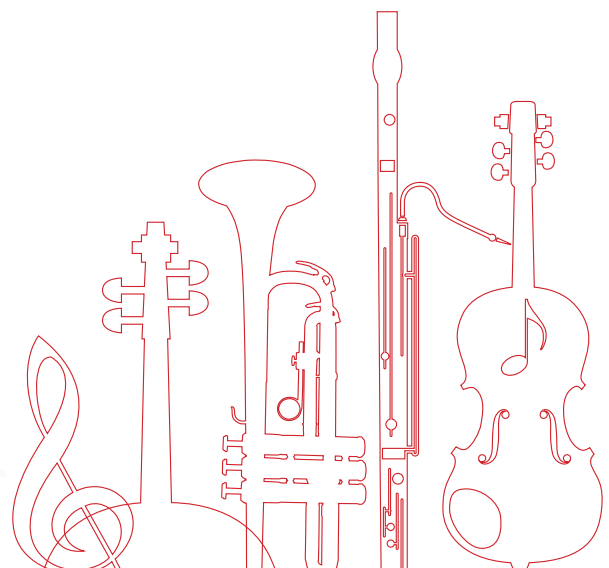

小
提
琴



王耀漳 | 天津音乐学院附中

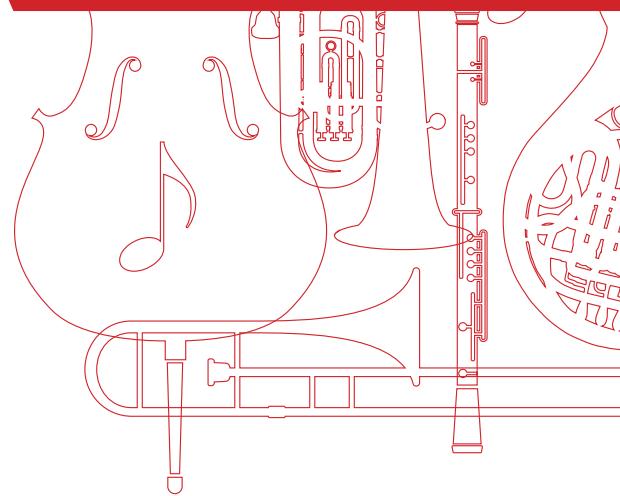

NYO CHINA
中华青少年交响乐团

2019

欧 | 洲 | 巡 | 演 |



小
提
琴

王禹哲 | 上海音乐学院附中



NYO CHINA
中华青少年交响乐团

2019

| 欧 | 洲 | 巡 | 演 |

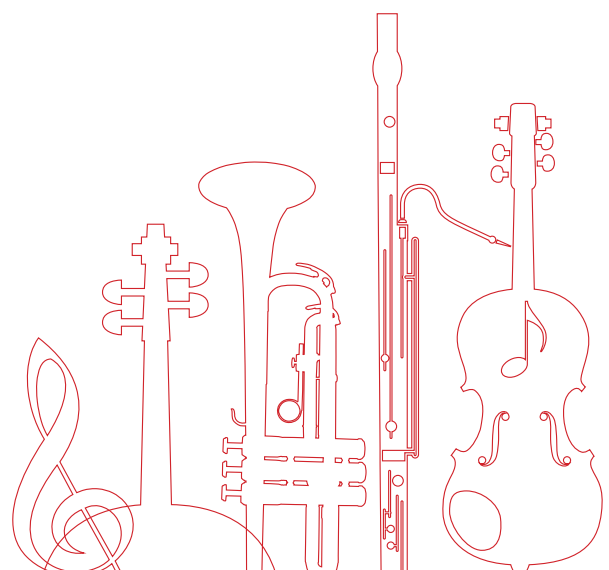

小
提
琴



魏佳宝 | 美国茱莉亚学院

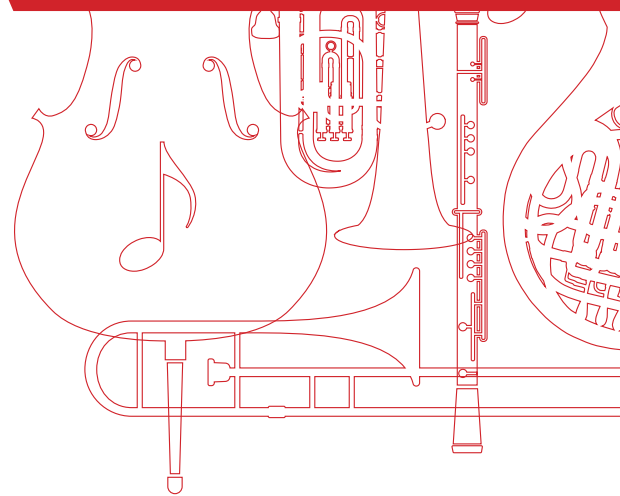

NYO CHINA
中华青少年交响乐团

2019

欧 | 洲 | 巡 | 演 |



小
提
琴

吴沛轩 | 中央音乐学院附中



NYO CHINA
中华青少年交响乐团

2019

| 欧 | 洲 | 巡 | 演 |

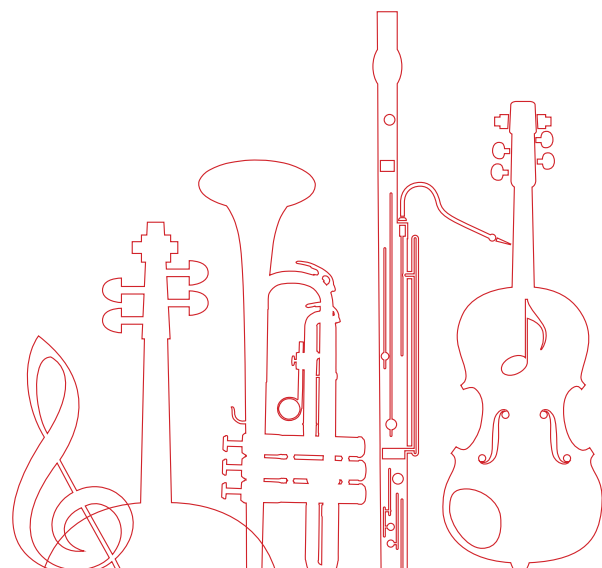

小
提
琴



颜 鲲 | 美国新英格兰音乐学院

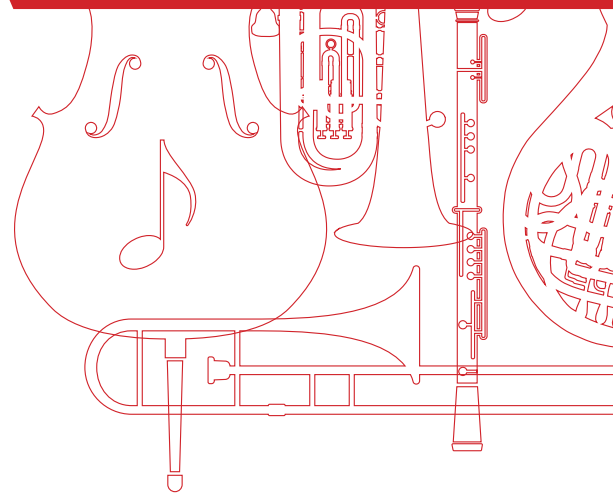

NYO CHINA
中华青少年交响乐团

2019

欧 | 洲 | 巡 | 演 |



小
提
琴

杨高扬 | 上海音乐学院

NYO CHINA
中华青少年交响乐团

2019

欧 | 洲 | 巡 | 演 |



小
提
琴



俞果 | 华东师范大学

NYO CHINA
中华青少年交响乐团

2019

欧 | 洲 | 巡 | 演 |



于若然 | 美国胡桃山艺术高中



小
提
琴



NYO CHINA
中华青少年交响乐团

2019

| 欧 | 洲 | 巡 | 演 |

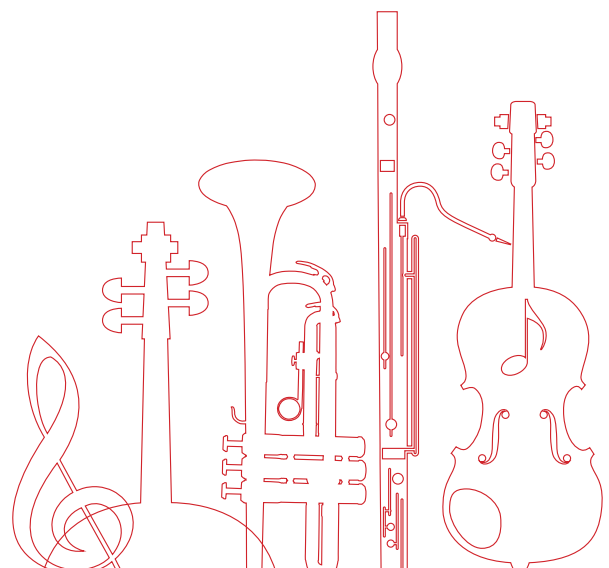

小
提
琴



余诗曼 | 中央音乐学院

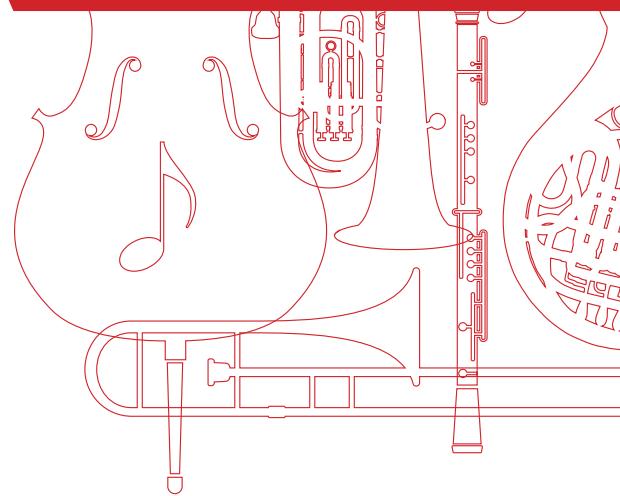

NYO CHINA
中华青少年交响乐团

2019

欧 | 洲 | 巡 | 演 |



张铭哲 | 上海音乐学院附中



小
提
琴

NYO CHINA
中华青少年交响乐团

2019

| 欧 | 洲 | 巡 | 演 |

小提琴



赵一甲 | 中央音乐学院

NYO CHINA
中华青少年交响乐团

2019

欧 | 洲 | 巡 | 演 |



小
提
琴

赵聿崧 | 美国哈特福德大学
哈特音乐学院



NYO CHINA
中华青少年交响乐团

2019

| 欧 | 洲 | 巡 | 演 |

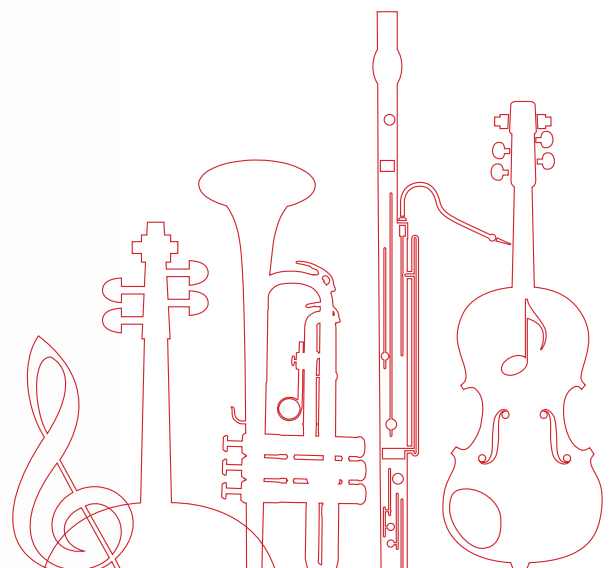

小
提
琴



周一凡 | 上海音乐学院附中

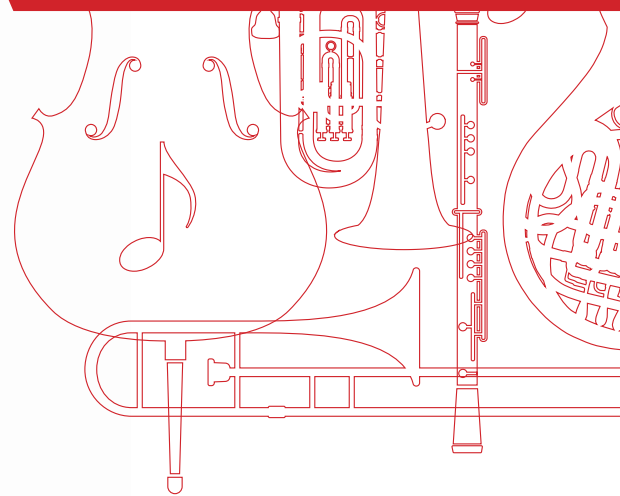

NYO CHINA
中华青少年交响乐团

2019

欧 | 洲 | 巡 | 演 |



中
提
琴

曹澜 | 新加坡杨秀桃音乐学院

NYO CHINA
中华青少年交响乐团

2019

| 欧 | 洲 | 巡 | 演 |

中
提
琴

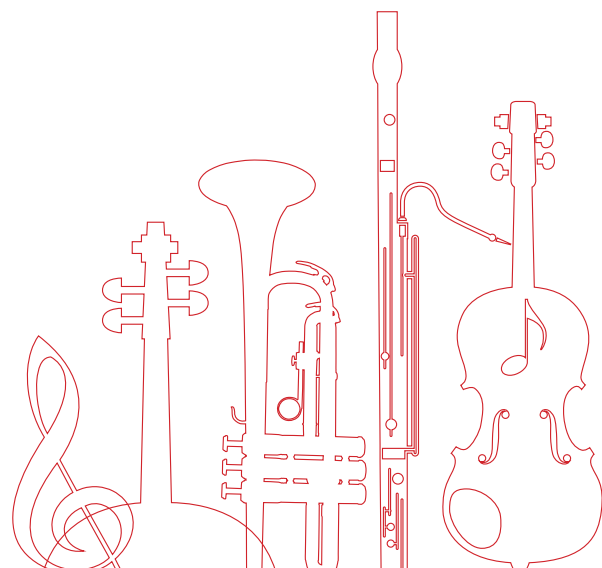

韩佳彤 | 中央音乐学院

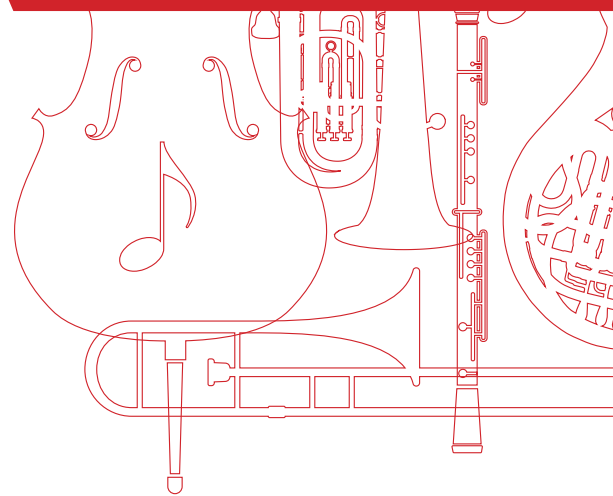

NYO CHINA
中华青少年交响乐团

2019

欧 | 洲 | 巡 | 演 |



中
提
琴

黄万欣怡 | 新加坡杨秀桃音乐学院

NYO CHINA
中华青少年交响乐团

2019

| 欧 | 洲 | 巡 | 演 |

中
提
琴

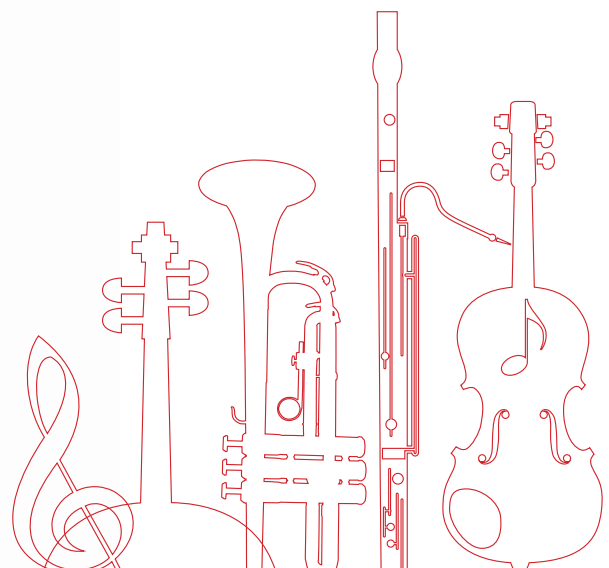

李书杪 | 中央音乐学院

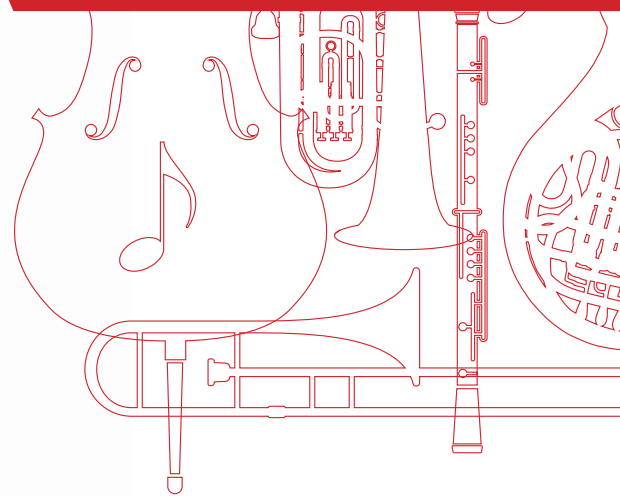

NYO CHINA
中华青少年交响乐团

2019

欧 | 洲 | 巡 | 演 |



中
提
琴

刘馨雨 | 上海音乐学院附中



NYO CHINA
中华青少年交响乐团

2019

| 欧 | 洲 | 巡 | 演 |

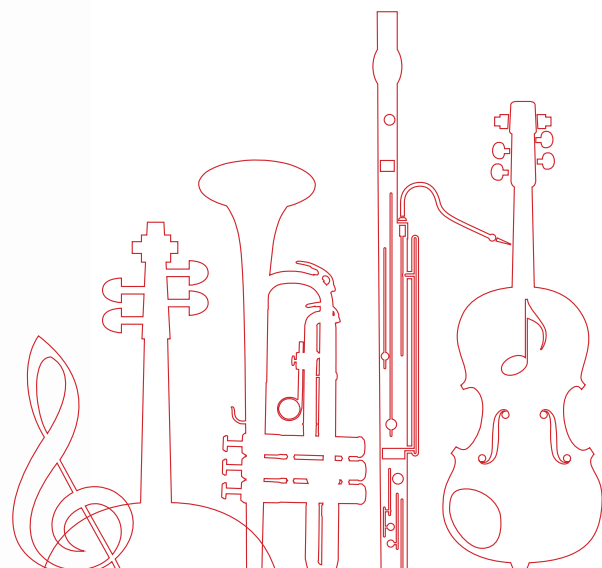

中
提
琴



石豪洋 | 美国新英格兰音乐学院

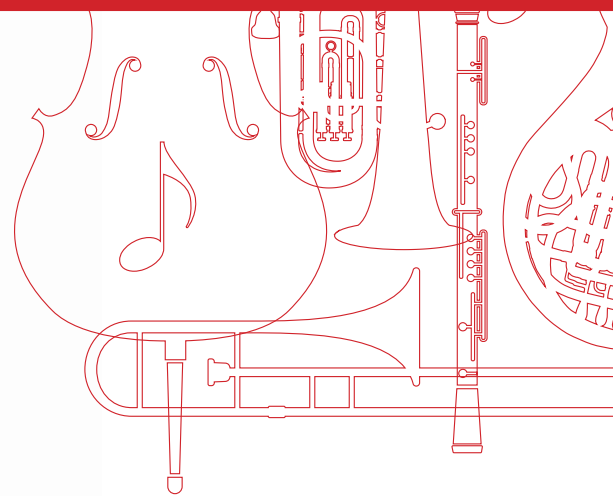

NYO CHINA
中华青少年交响乐团

2019

欧 | 洲 | 巡 | 演 |



中
提
琴

魏琪 | 比利时那慕尔高
音乐教育学院

NYO CHINA
中华青少年交响乐团

2019

| 欧 | 洲 | 巡 | 演 |

中
提
琴

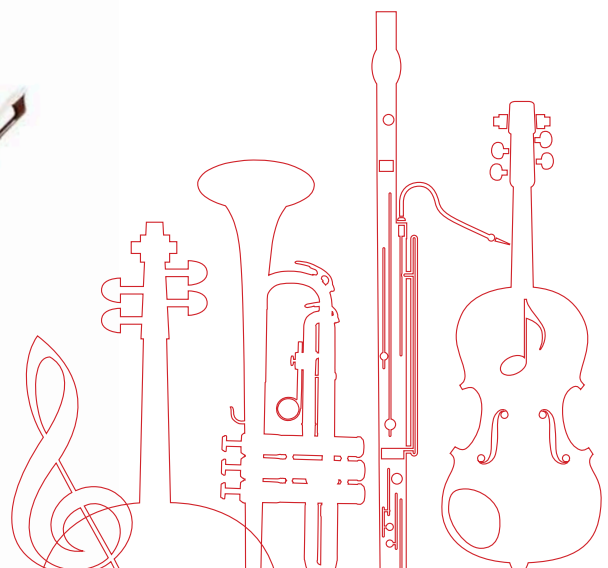

徐硕 | 上海音乐学院附中

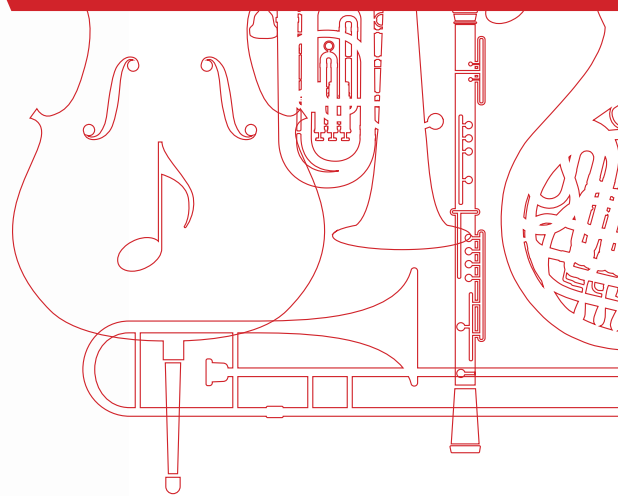

NYOCHINA
中华青少年交响乐团

2019

欧 | 洲 | 巡 | 演 |



中
提
琴

张瀚平 | 上海音乐学院



NYO CHINA
中华青少年交响乐团

2019

| 欧 | 洲 | 巡 | 演 |

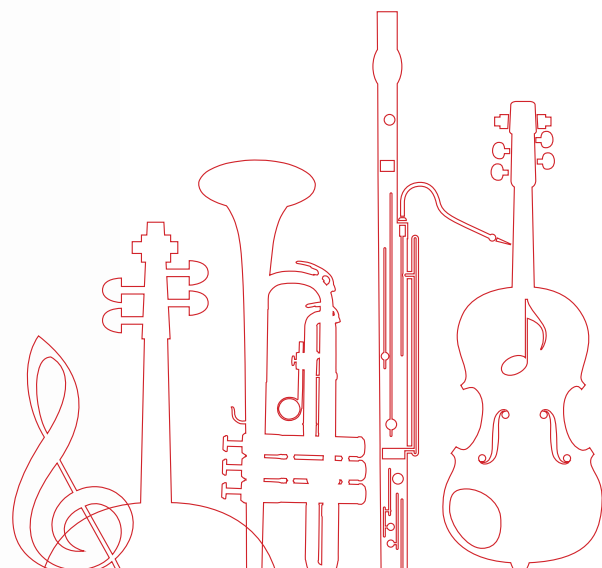

中
提
琴



章晰尧 | 上海音乐学院附中

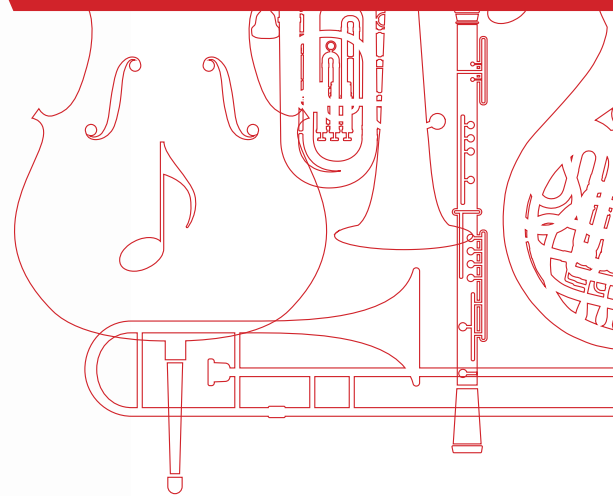

NYO CHINA
中华青少年交响乐团

2019

欧 | 洲 | 巡 | 演 |



中
提
琴

张薰之 | 上海音乐学院附中

NYO CHINA
中华青少年交响乐团

2019

欧 | 洲 | 巡 | 演 |

中
提
琴

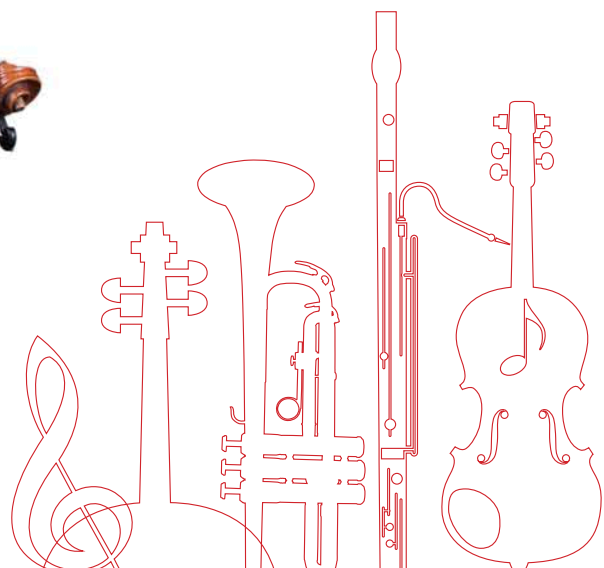

张雨菲 | 上海音乐学院附中

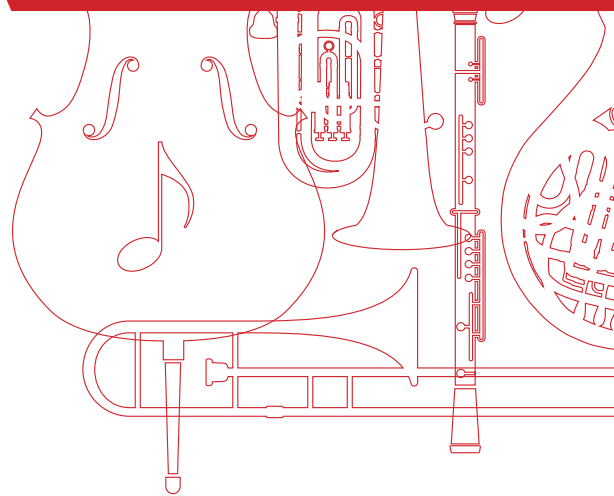

NYO CHINA
中华青少年交响乐团

2019

欧 | 洲 | 巡 | 演 |



中
提
琴

朱鹏熹 | 中央音乐学院附中

NYO CHINA
中华青少年交响乐团

2019

| 欧 | 洲 | 巡 | 演 |

大
提
琴

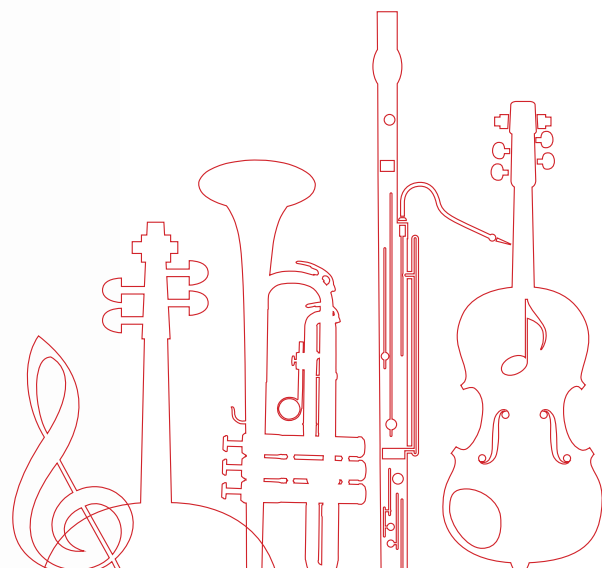

陈俊羽 | 上海音乐学院

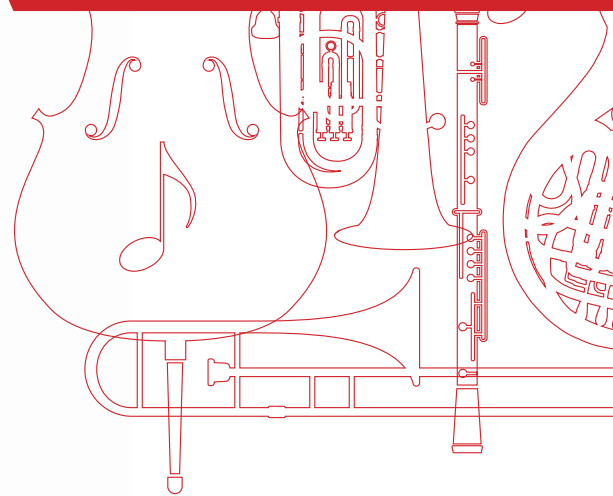

NYO CHINA
中华青少年交响乐团

2019

欧 | 洲 | 巡 | 演 |



大
提
琴

胡晨一 | 美国胡桃山艺术高中

NYO CHINA
中华青少年交响乐团

2019

欧 | 洲 | 巡 | 演 |

大
提
琴



刘一朵 | 上海音乐学院附中

NYO CHINA
中华青少年交响乐团

2019

欧 | 洲 | 巡 | 演 |



大提琴

夏怡熙 | 上海音乐学院

**NYO CHINA**
中华青少年交响乐团

2019

| 欧 | 洲 | 巡 | 演 |



大
提
琴



许欣智 | 上海音乐学院

NYO CHINA
中华青少年交响乐团

2019

欧 | 洲 | 巡 | 演 |



张竞源 | 中央音乐学院附中



大提琴

NYO CHINA
中华青少年交响乐团

2019

| 欧 | 洲 | 巡 | 演 |

大
提
琴

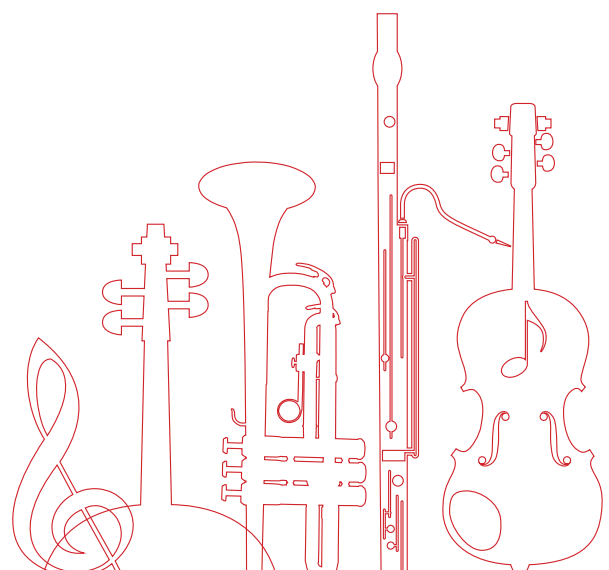

张园晨 | 中央音乐学院

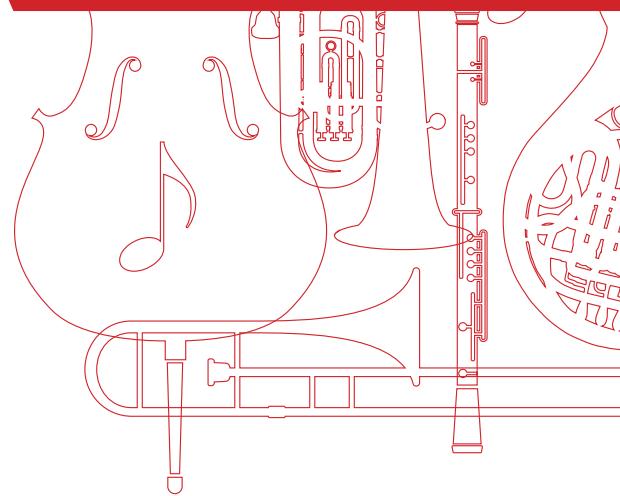

NYO CHINA
中华青少年交响乐团

2019

欧 | 洲 | 巡 | 演 |



大
提
琴

郑舒颐 | 上海音乐学院

**NYO CHINA**
中华青少年交响乐团

2019

欧 | 洲 | 巡 | 演 |

大
提
琴



朱天橙 | 加拿大麦克奈尔中学

NYO CHINA
中华青少年交响乐团

2019

欧 | 洲 | 巡 | 演 |



大提琴

朱歆乐 | 上海音乐学院附中

NYO CHINA
中华青少年交响乐团

2019

| 欧 | 洲 | 巡 | 演 |

大
提
琴

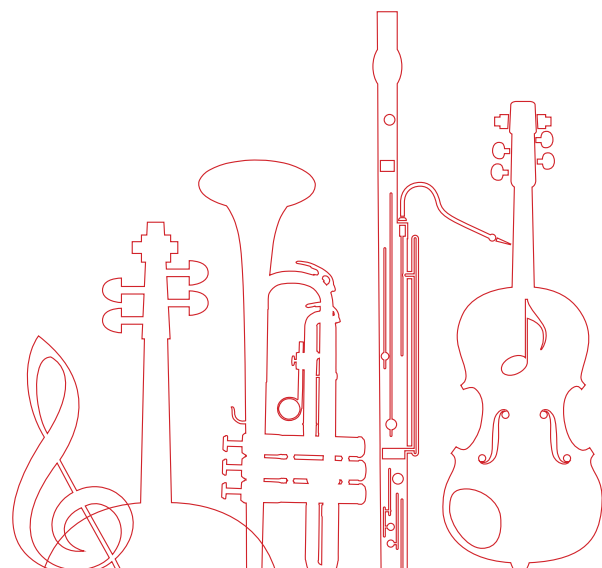

朱元丰 | 上海音乐学院

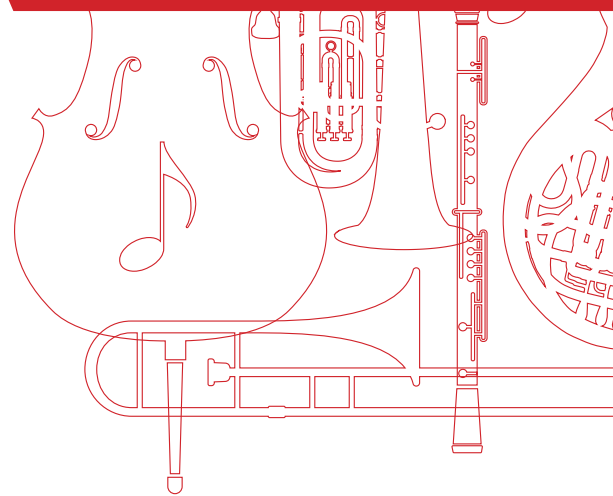



NYO CHINA
中华青少年交响乐团

2019

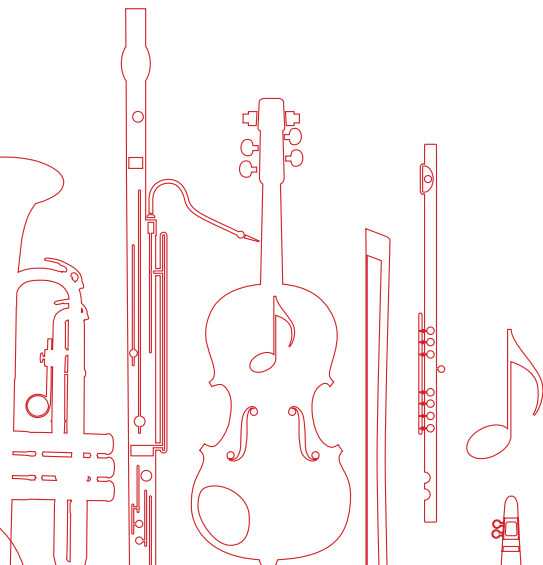
欧 | 洲 | 巡 | 演 |

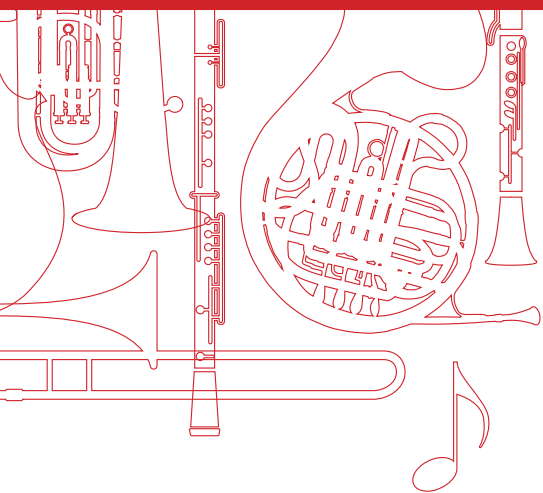

朱原玉婕 | 中央音乐学院附中



大提琴



NYO CHINA
中华青少年交响乐团

2019

欧 | 洲 | 巡 | 演 |

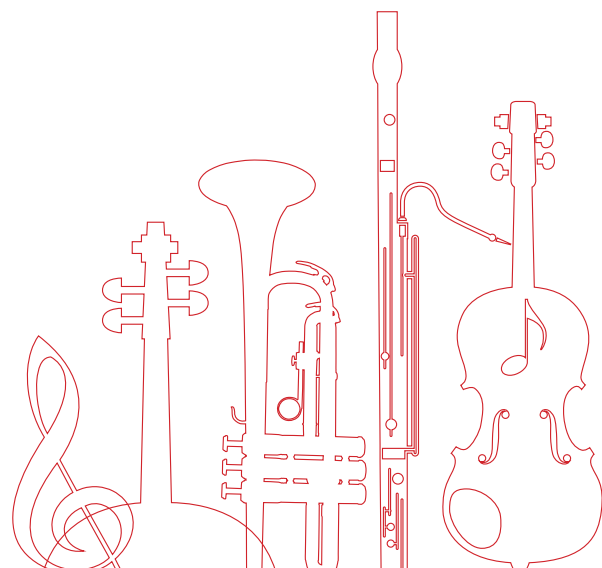

低
音
提
琴



哈博文 | 美国英特洛肯艺术中学

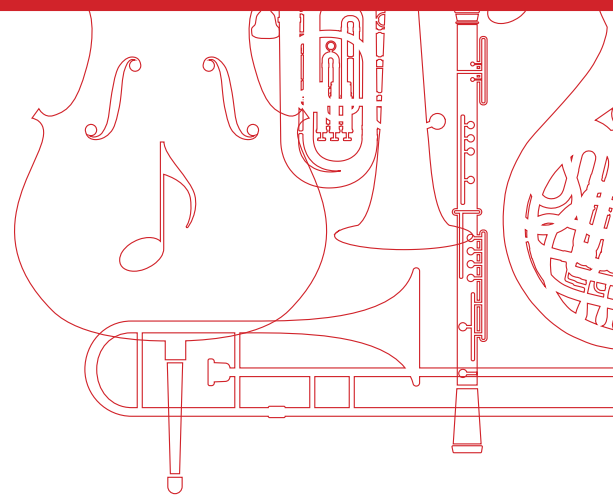

NYOCHINA
中华青少年交响乐团

2019

欧 | 洲 | 巡 | 演 |



低
音
提
琴

路震远 | 上海音乐学院附中

NYO CHINA
中华青少年交响乐团

2019

欧 | 洲 | 巡 | 演 |

低
音
提
琴

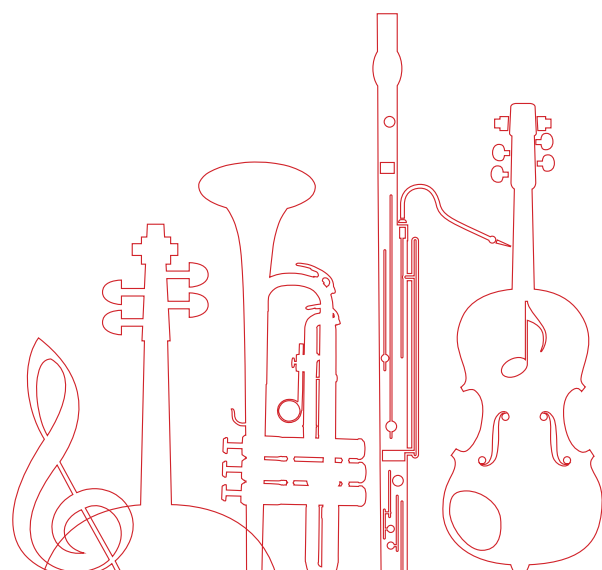

满格格 | 新加坡杨秀桃音乐学院

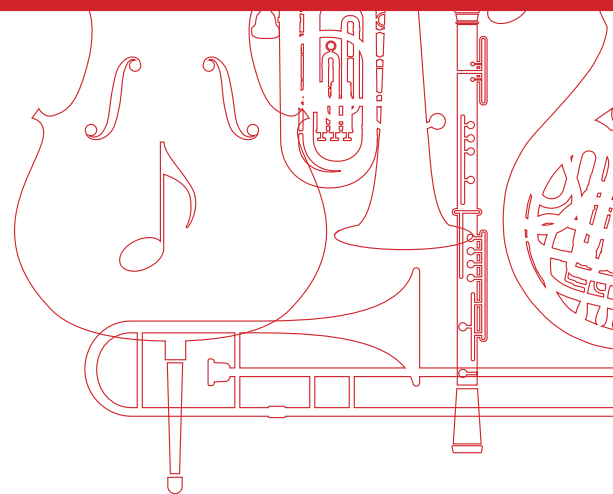

NYO CHINA
中华青少年交响乐团

2019

欧 | 洲 | 巡 | 演 |

低
音
提
琴

涂馨匀 | 新加坡杨秀桃音乐学院





NYO CHINA
中华青少年交响乐团

2019

| 欧 | 洲 | 巡 | 演 |

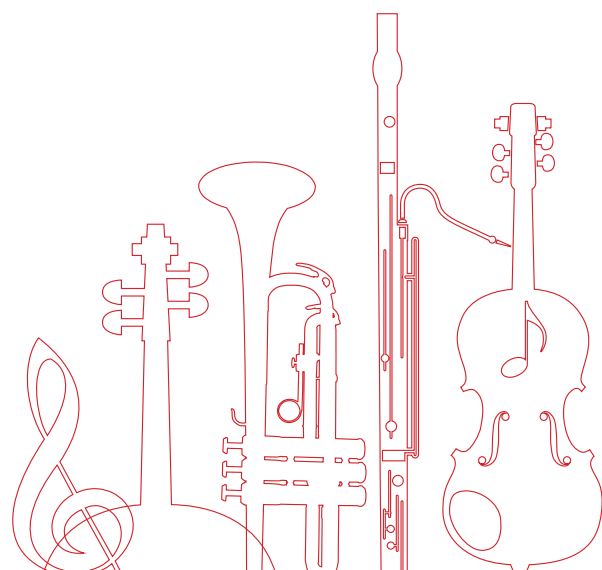
低音提琴



王明圆 | 新加坡杨秀桃音乐学院

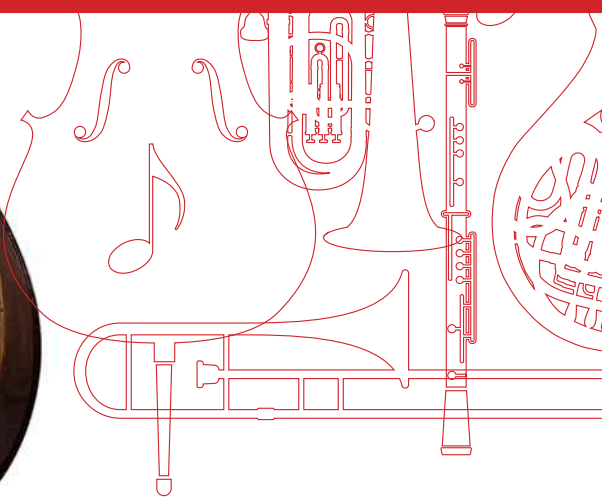

NYO CHINA
中华青少年交响乐团

2019

欧 | 洲 | 巡 | 演 |



低音提琴

吴亦涵 | 美国英特洛肯艺术中学



NYO CHINA
中华青少年交响乐团

2019

| 欧 | 洲 | 巡 | 演 |

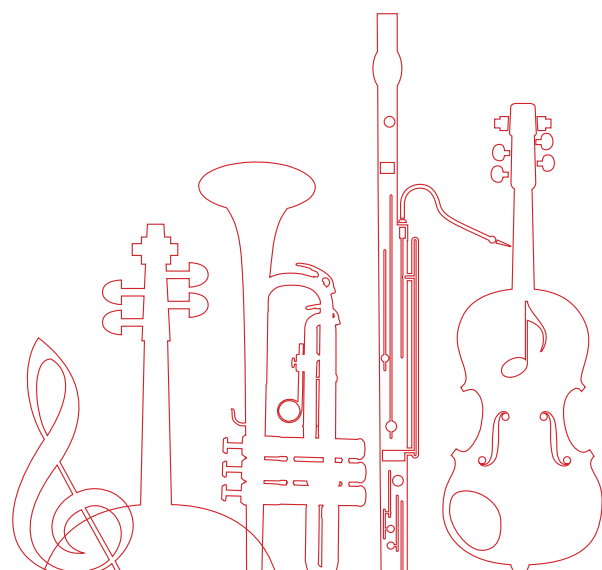

低
音
提
琴



祝国宁 | 苏州大学音乐学院

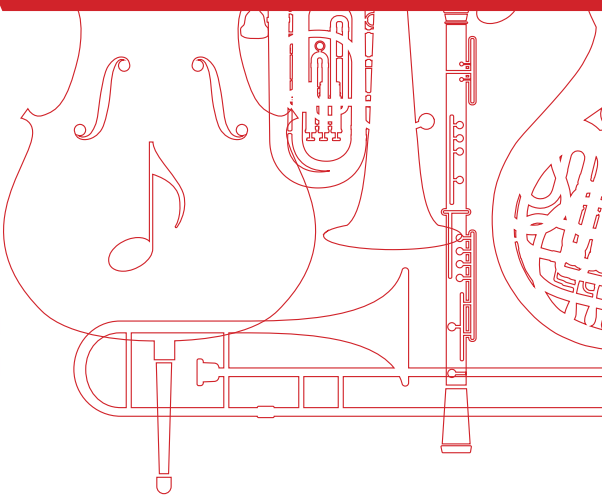

NYO CHINA
中华青少年交响乐团

2019

欧 | 洲 | 巡 | 演 |



低音提琴

朱靖霖 | 上海音乐学院



NYO CHINA
中华青少年交响乐团

2019

| 欧 | 洲 | 巡 | 演 |

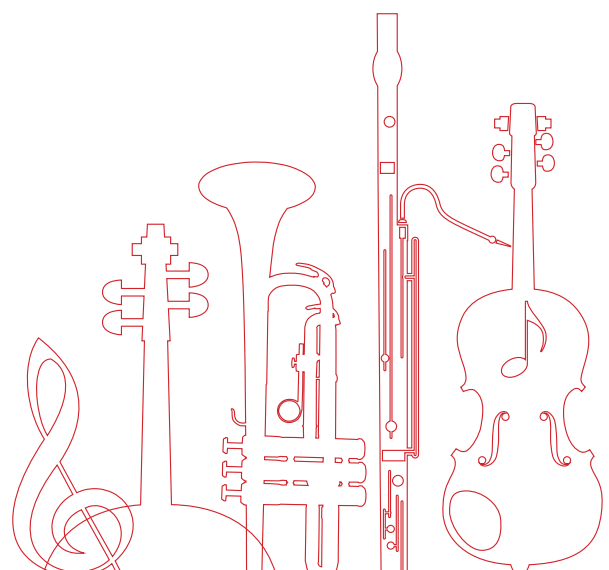

长
笛



党雅馨 | 武汉音乐学院附中

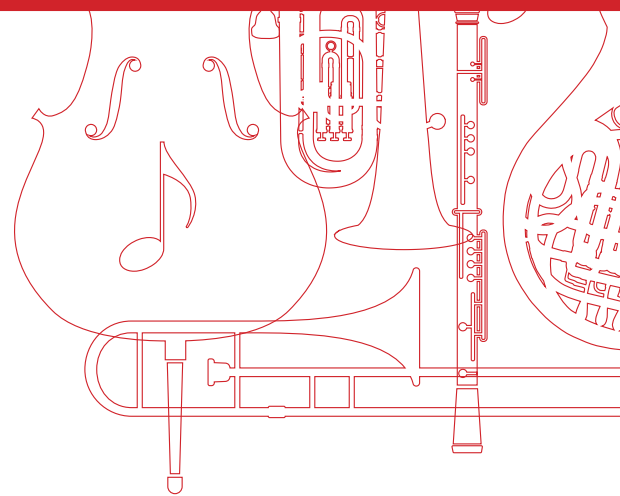



NYO CHINA
中华青少年交响乐团

2019

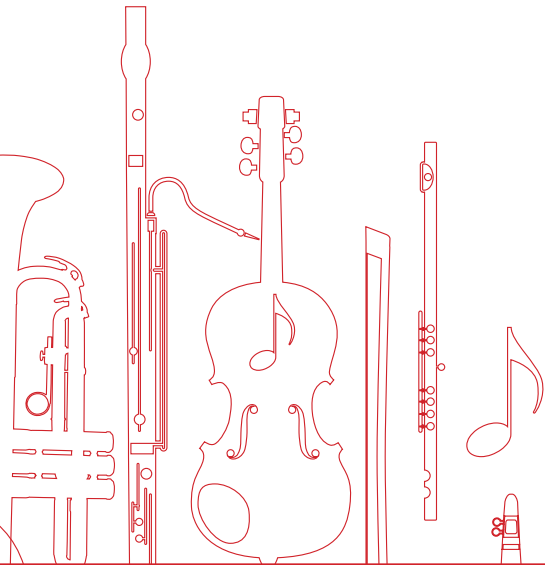
欧 | 洲 | 巡 | 演 |

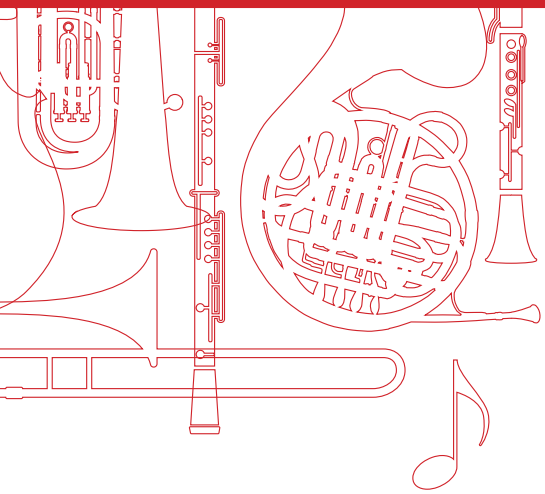

卢柯宇 | 中央音乐学院附中



长
笛

NYO CHINA
中华青少年交响乐团

2019

欧 | 洲 | 巡 | 演 |

长
笛

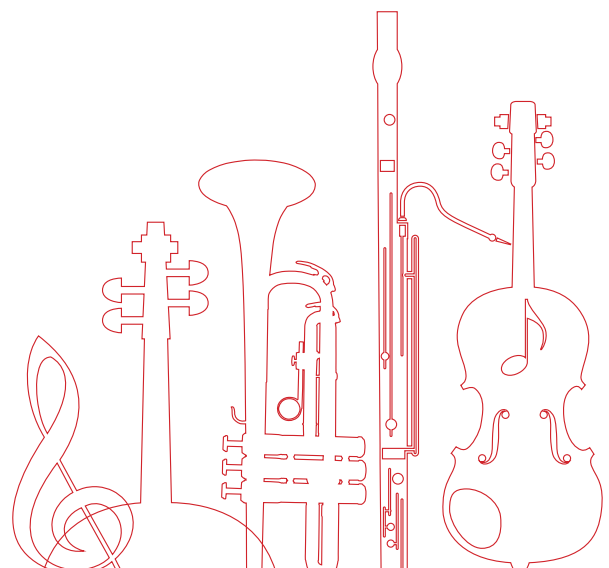

宁可 | 西安音乐学院附中

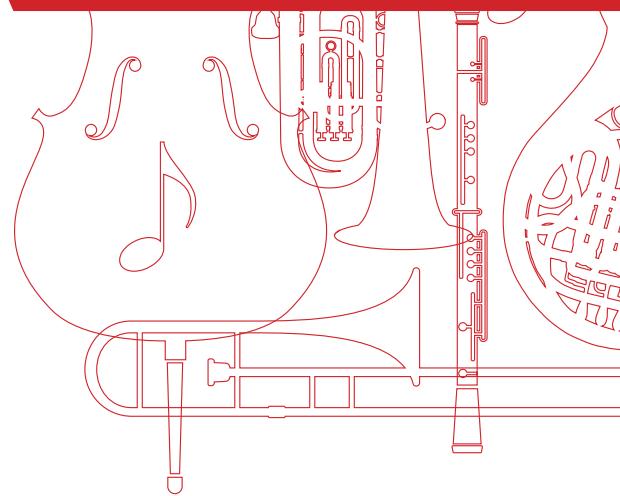



NYO CHINA
中华青少年交响乐团

2019

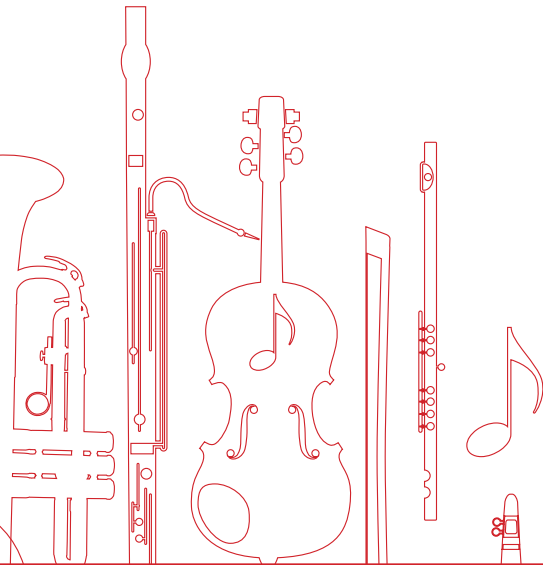
欧 | 洲 | 巡 | 演 |

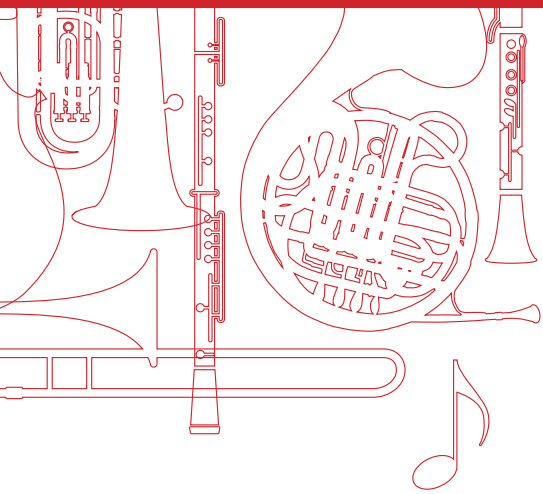

于渊 | 巴黎国立高等音乐舞蹈学院



长
笛

NYO CHINA
中华青少年交响乐团

2019

| 欧 | 洲 | 巡 | 演 |

单簧管

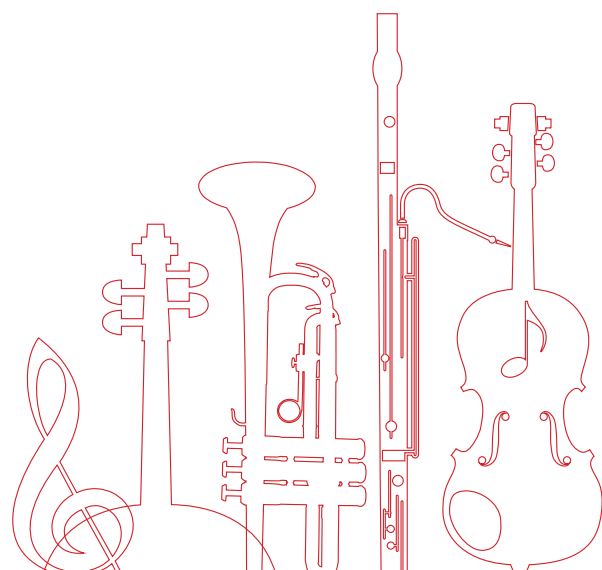

姜尚均 | 美国艾迪怀德艺术高中

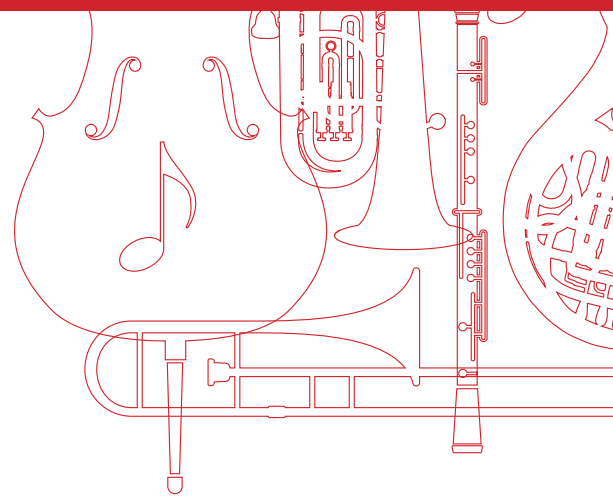

NYO CHINA
中华青少年交响乐团

2019

欧 | 洲 | 巡 | 演 |



单簧管

刘岩 | 美国柯蒂斯音乐学院

NYO CHINA
中华青少年交响乐团

2019

| 欧 | 洲 | 巡 | 演 |

单簧管

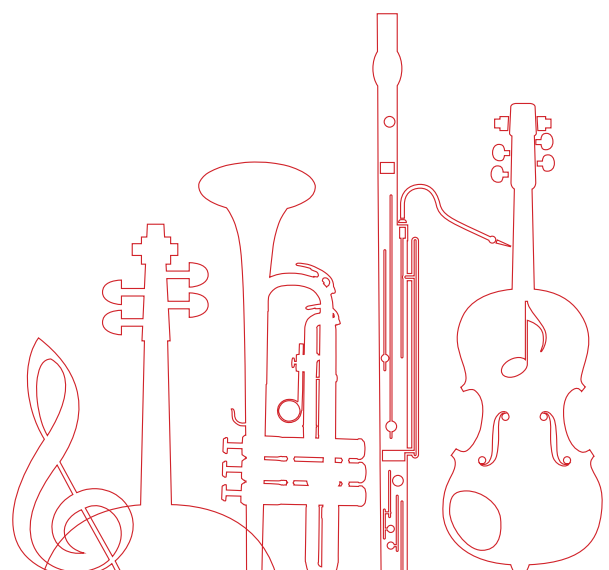

倪郅炜 | 美国柯尔本音乐学院

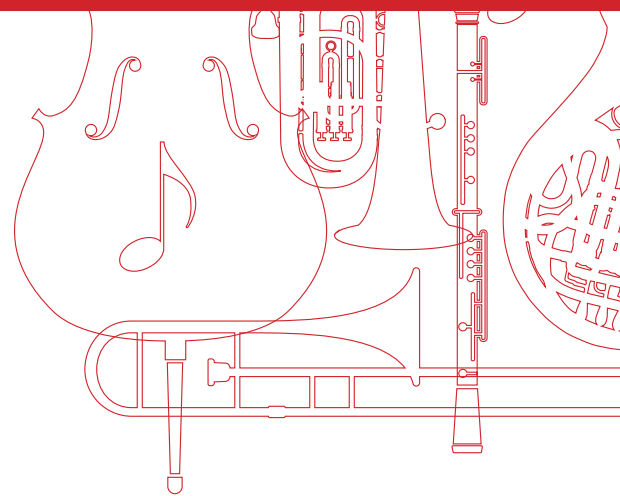

NYOCHINA
中华青少年交响乐团

2019

欧 | 洲 | 巡 | 演 |

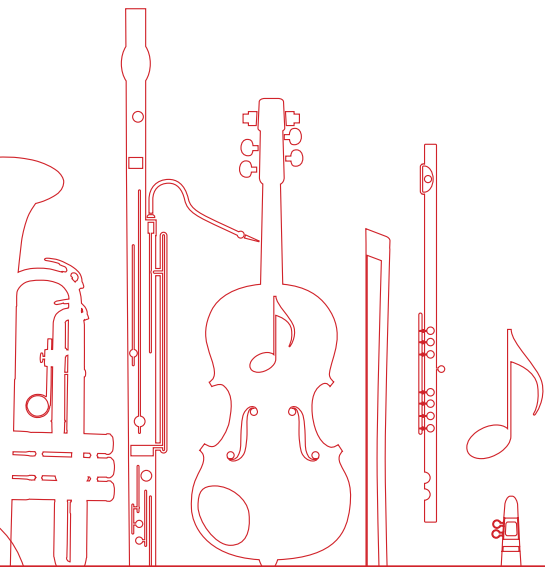

邹汇斌 | 美国克利夫兰音乐学院

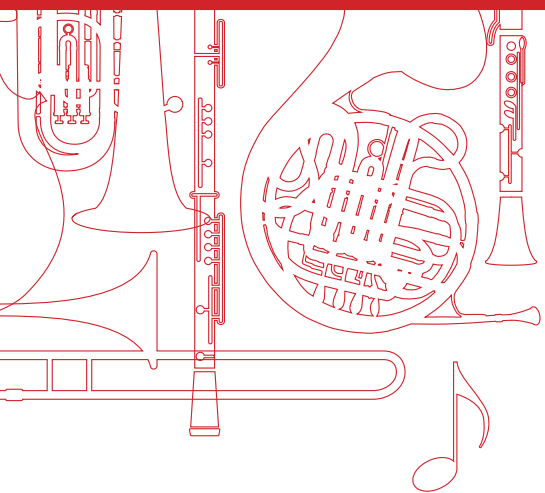

单簧管

**NYO CHINA**
中华青少年交响乐团

2019

欧 | 洲 | 巡 | 演 |

双
簧
管

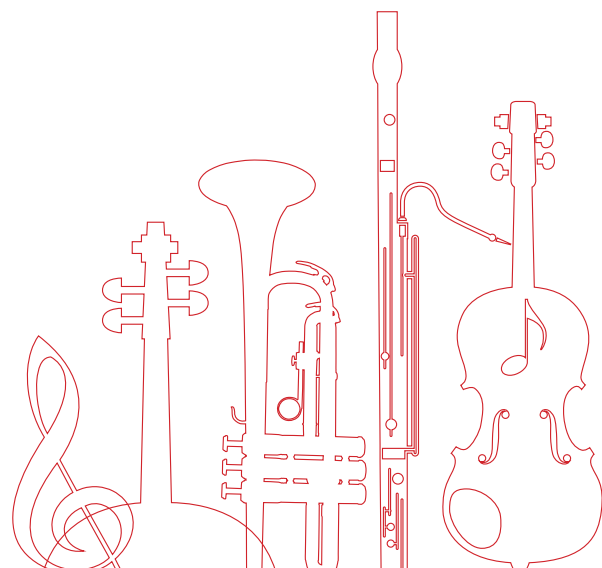

林泓泓 | 中央音乐学院附中

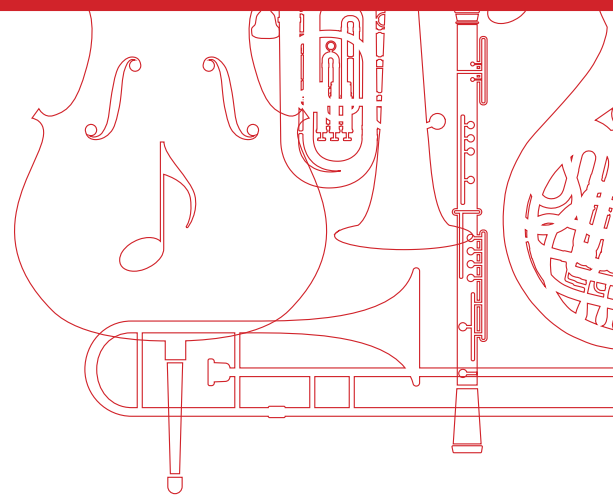

NYOCHINA
中华青少年交响乐团

2019

欧 | 洲 | 巡 | 演 |



双
簧
管

陆咏琪 | 新加坡杨秀桃音乐学院

NYO CHINA
中华青少年交响乐团

2019

| 欧 | 洲 | 巡 | 演 |

双簧管

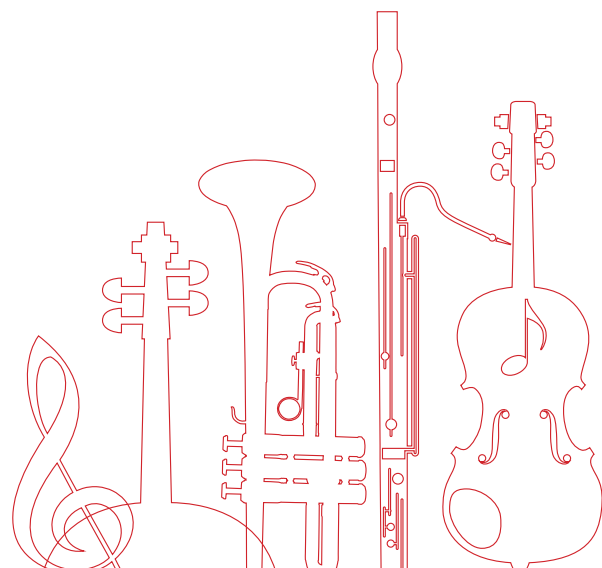

肖遥 | 中国人民大学

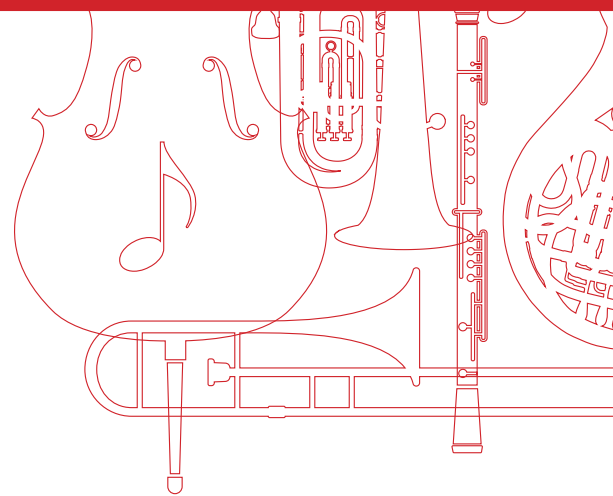

NYOCHINA
中华青少年交响乐团

2019

欧 | 洲 | 巡 | 演 |



双
簧
管

朱一睿 | 上海音乐学院附中

NYOCHINA
中华青少年交响乐团

2019

欧 | 洲 | 巡 | 演 |

巴
松
管



郭巴平 | 中央音乐学院附中

NYO CHINA
中华青少年交响乐团

2019

欧|洲|巡|演|



巴
松
管

牛佳雯 | 上海音乐学院

NYO CHINA
中华青少年交响乐团

2019

欧 | 洲 | 巡 | 演 |

巴
松
管

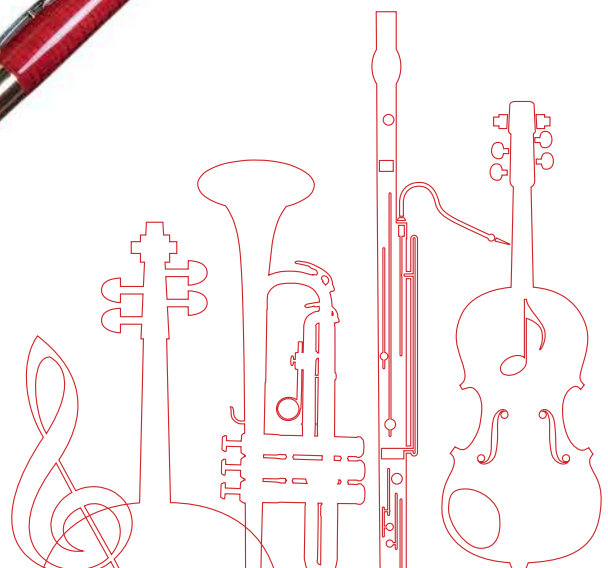

王铎 | 中央音乐学院

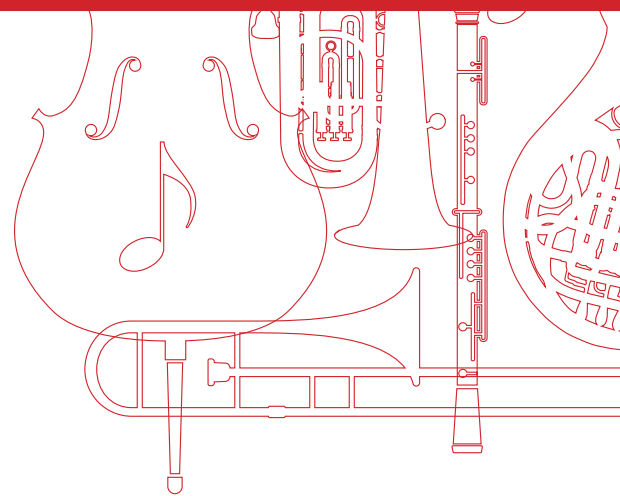

NYOCHINA
中华青少年交响乐团

2019

欧 | 洲 | 巡 | 演 |



巴
松
管

杨焯 | 四川音乐学院附中



NYO CHINA
中华青少年交响乐团

2019

| 欧 | 洲 | 巡 | 演 |

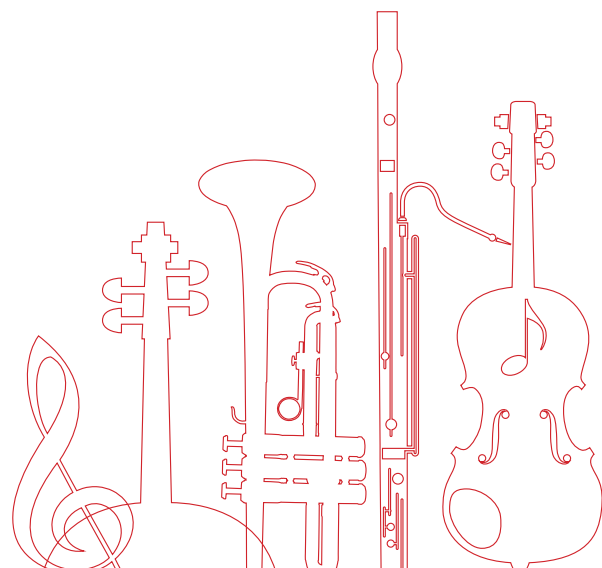

圆号



矫咏含 | 深圳市北京师范大学
附属南山分校

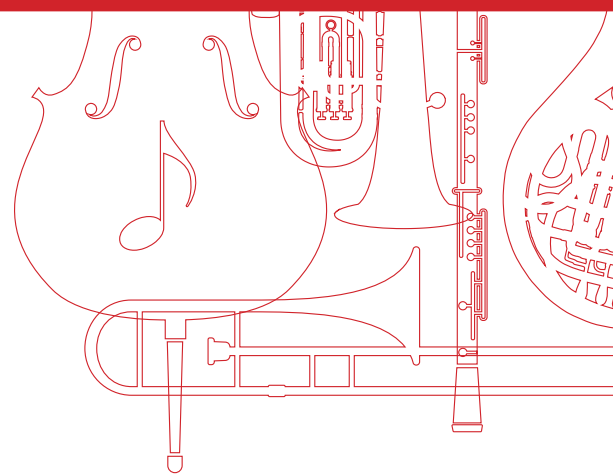

NYOCHINA
中华青少年交响乐团

2019

欧 | 洲 | 巡 | 演 |



圆号

林琦 | 中央音乐学院附中

**NYO CHINA**
中华青少年交响乐团

2019

| 欧 | 洲 | 巡 | 演 |



圆号

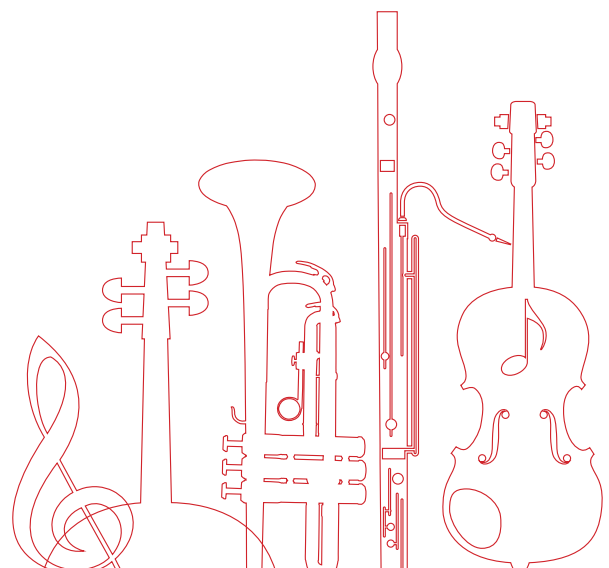

欧阳贝俐 | 上海音乐学院附中

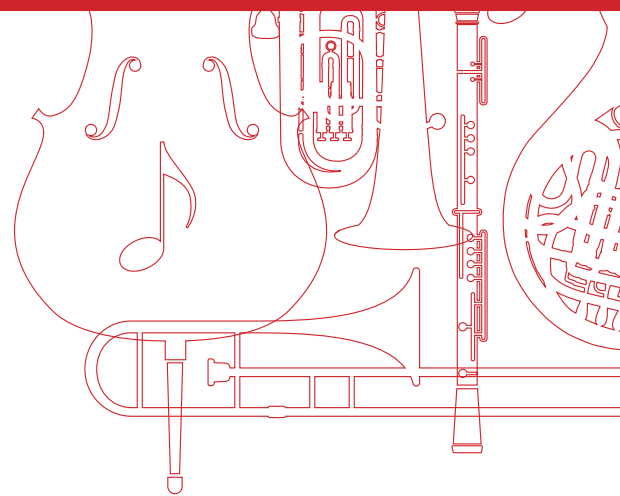

NYO CHINA
中华青少年交响乐团

2019

欧 | 洲 | 巡 | 演 |



圆号

宋嘉洵 | 中央音乐学院

NYO CHINA
中华青少年交响乐团

2019

| 欧 | 洲 | 巡 | 演 |



圆号

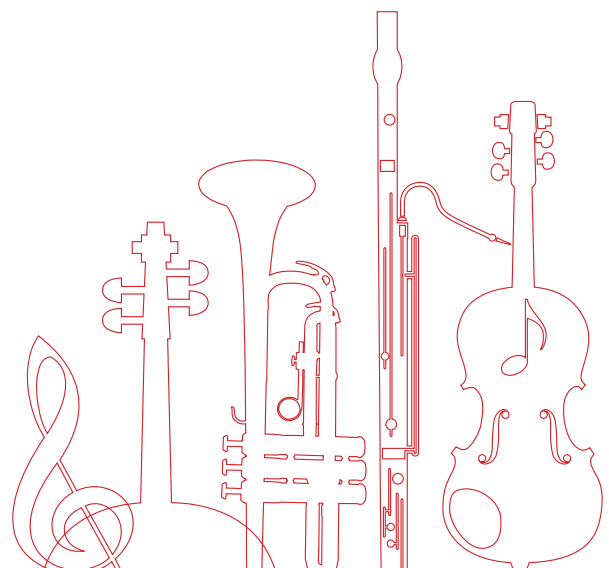

唐曜祺 | 中央音乐学院

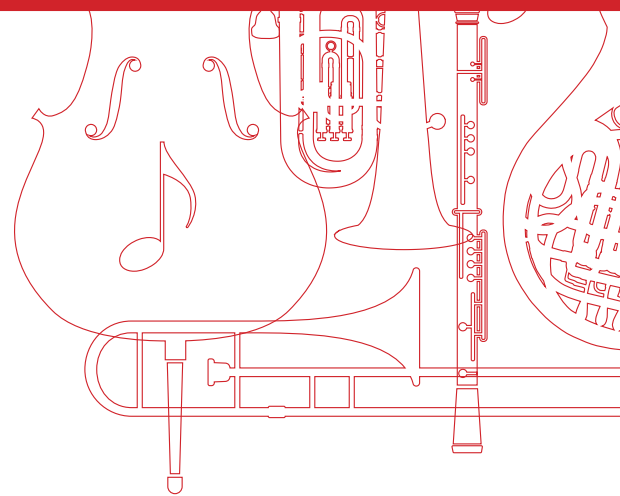

NYO CHINA
中华青少年交响乐团

2019

欧 | 洲 | 巡 | 演 |



圆号

朱尊泰 | 中国音乐学院附中

**NYO CHINA**
中华青少年交响乐团

2019

| 欧 | 洲 | 巡 | 演 |

小号

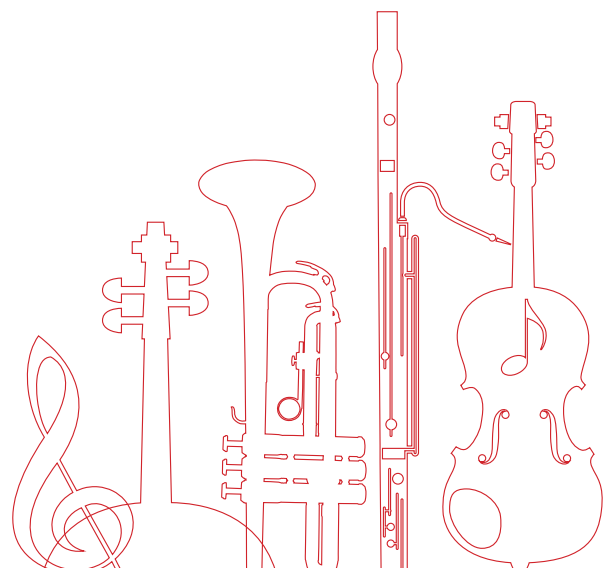

纪政旭 | 中央音乐学院附中

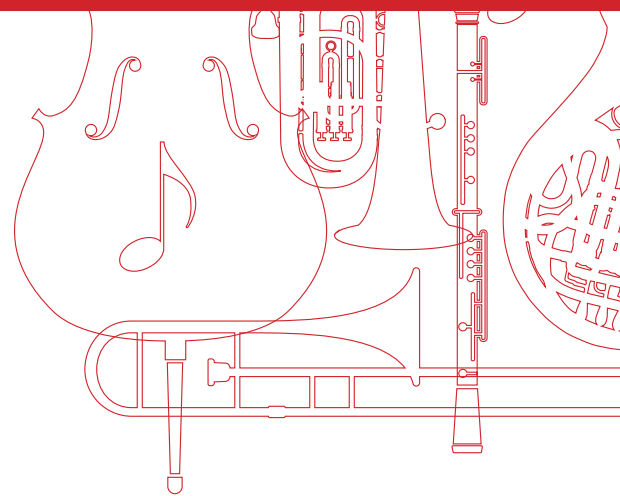

NYO CHINA
中华青少年交响乐团

2019

欧 | 洲 | 巡 | 演 |



小号

刘兆庭 | 中央音乐学院

**NYO CHINA**
中华青少年交响乐团

2019

| 欧 | 洲 | 巡 | 演 |

小号

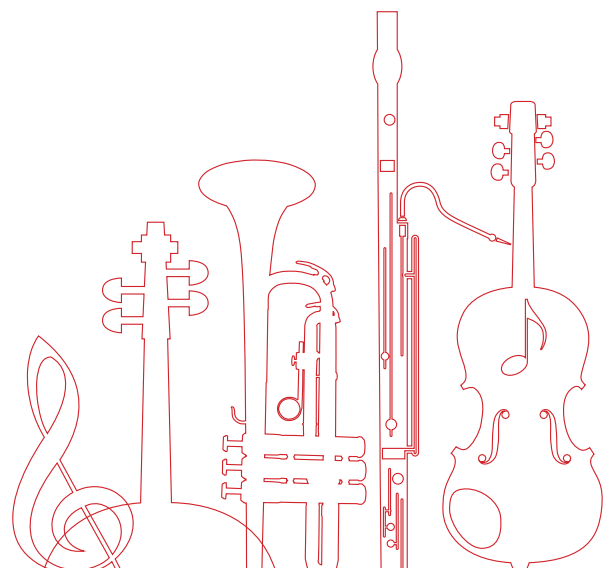

唐浩杉 | 中央音乐学院附中

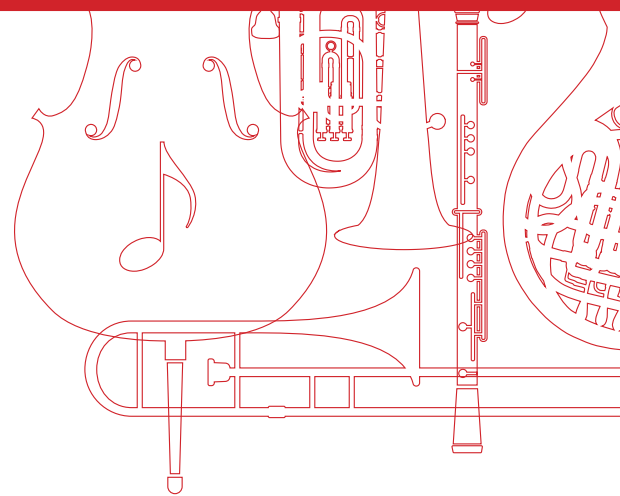

NYO CHINA
中华青少年交响乐团

2019

欧 | 洲 | 巡 | 演 |



小号

杨焕翊 | 美国胡桃山艺术高中

NYO CHINA
中华青少年交响乐团

2019

欧 | 洲 | 巡 | 演 |



长号



李翼霄 | 美国宾夕法尼亚大学

NYOCHINA
中华青少年交响乐团

2019

欧 | 洲 | 巡 | 演 |



仇嘉琿 | 上海音乐学院



长号

NYOCHINA
中华青少年交响乐团

2019

| 欧 | 洲 | 巡 | 演 |



长号

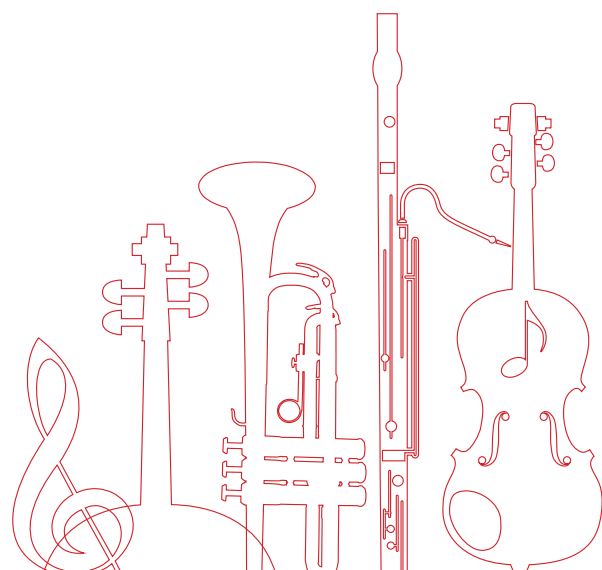

顾鸿亿 | 新加坡杨秀桃音乐学院

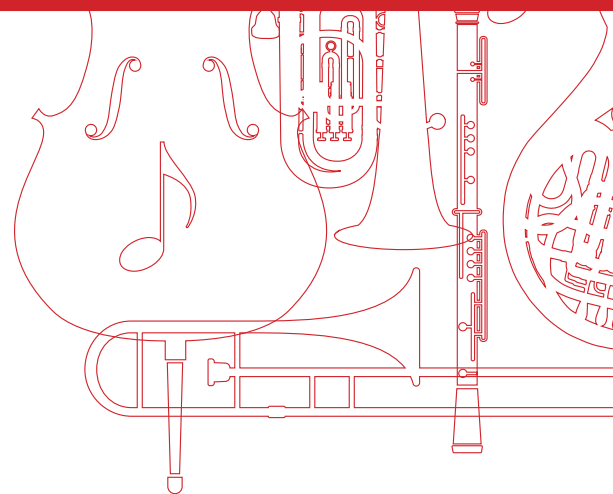

NYO CHINA
中华青少年交响乐团

2019

欧 | 洲 | 巡 | 演 |



大
号

方翔宇 | 美国胡桃山艺术高中

**NYO CHINA**
中华青少年交响乐团

2019

| 欧 | 洲 | 巡 | 演 |

打击乐器

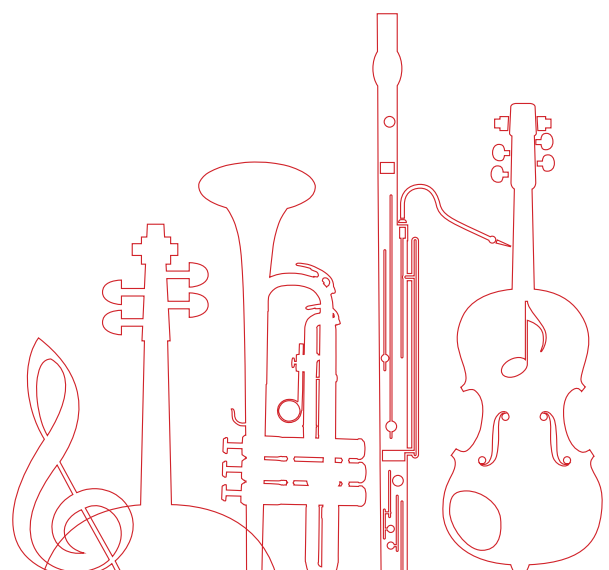

高思远 | 上海音乐学院附中

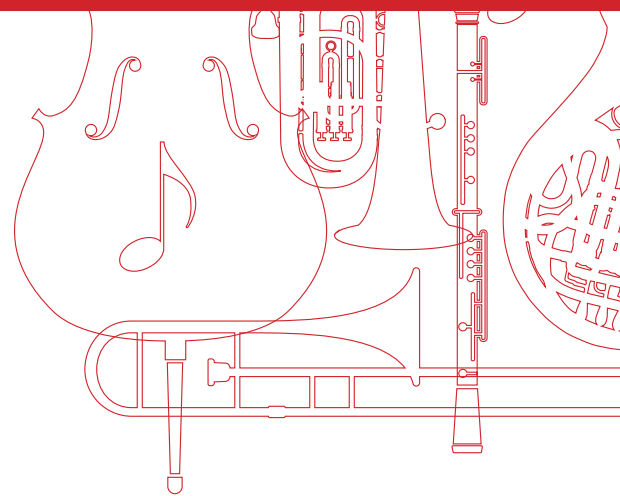

NYO CHINA
中华青少年交响乐团

2019

欧 | 洲 | 巡 | 演 |



打
击
乐
器

刘政泽 | 中央音乐学院

NYO CHINA
中华青少年交响乐团

2019

| 欧 | 洲 | 巡 | 演 |

打击乐器

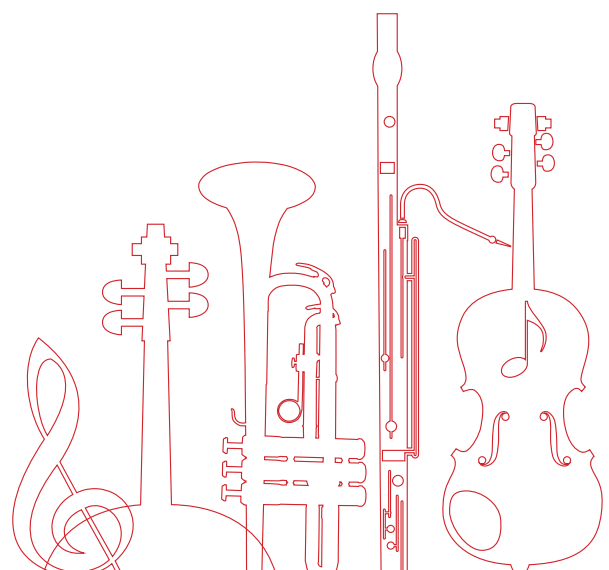

缪子威 | 四川音乐学院

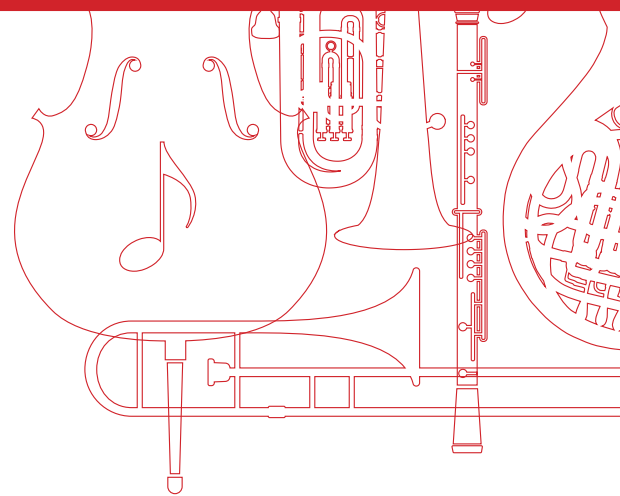

NYO CHINA
中华青少年交响乐团

2019

欧 | 洲 | 巡 | 演 |



打
击
乐
器

苑鑫 | 上海音乐学院

NYO CHINA
中华青少年交响乐团

2019

| 欧 | 洲 | 巡 | 演 |

打击乐器

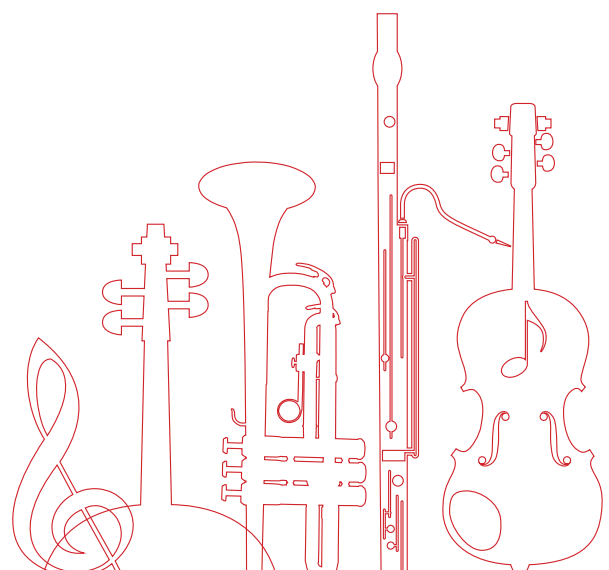

张柏杨 | 中央音乐学院附中

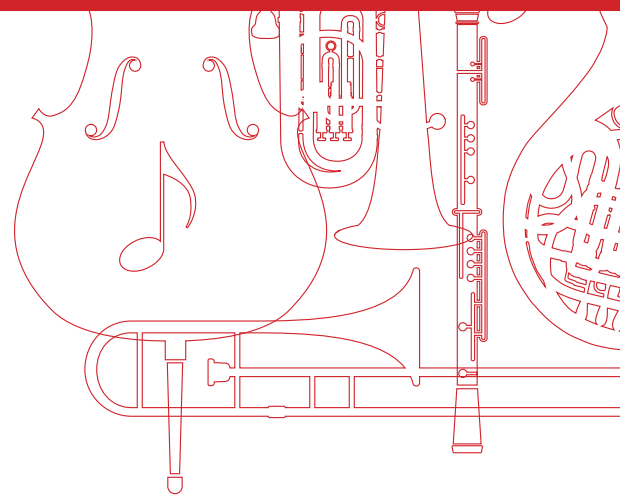



NYO CHINA
中华青少年交响乐团

2019

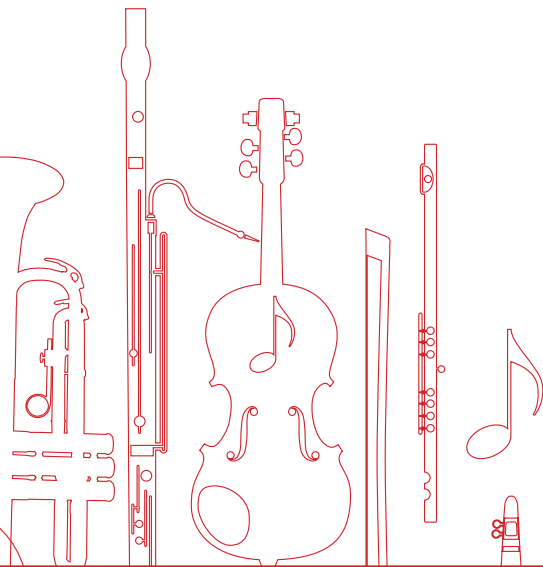
| 欧 | 洲 | 巡 | 演 |

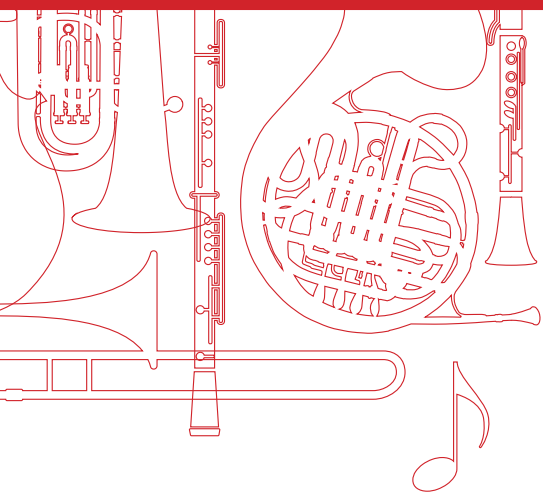

周芷伊 | 中央音乐学院



打
击
乐
器

NYO CHINA
中华青少年交响乐团

2019

| 欧 | 洲 | 巡 | 演 |

竖
琴

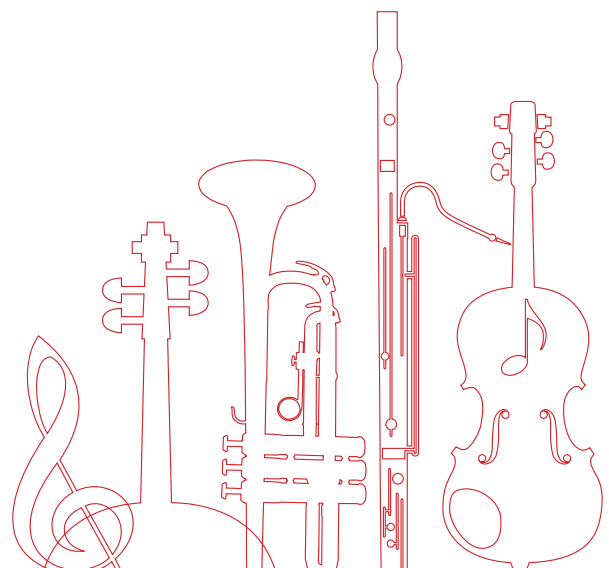

王佳楠 | 上海音乐学院

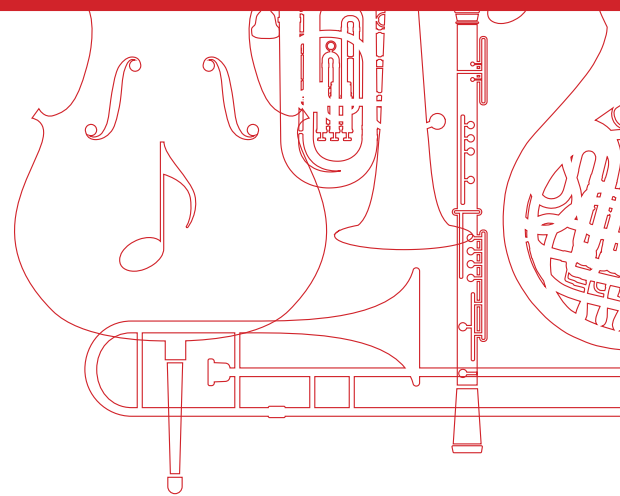



NYOCHINA
中华青少年交响乐团

2019

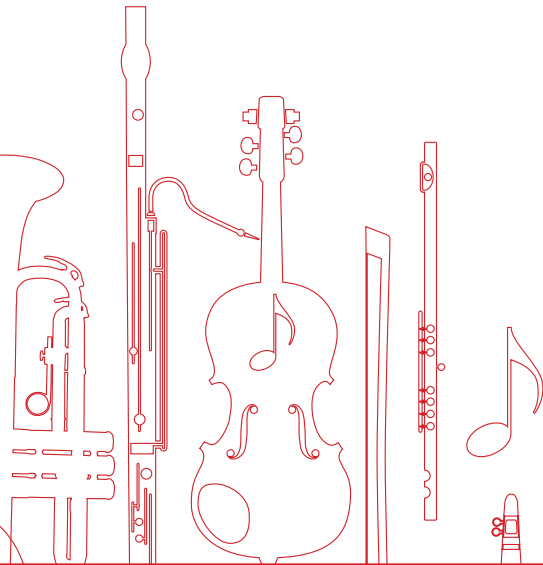
| 欧 | 洲 | 巡 | 演 |

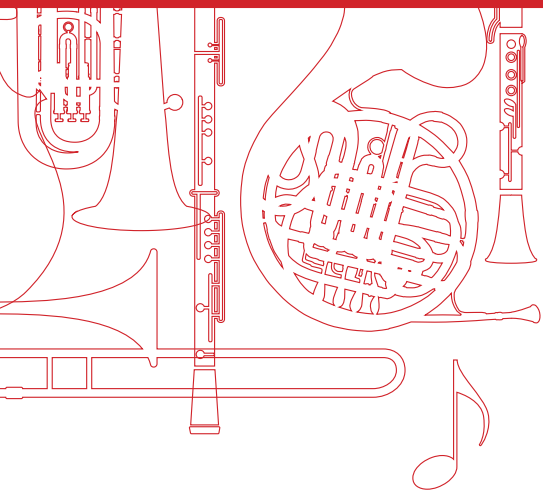

邹韩骄 | 上海音乐学院附中



竖
琴

NYO CHINA
中华青少年交响乐团

WWW.NYOCHINA.ORG



Facebook: NYOChina | Twitter: @NYOChina | WeChat: NYO-China | Weibo: NYO-China